

# 2015 Ethicon Product Catalog

**ETHICON**  
PART OF THE *Johnson & Johnson* FAMILY OF COMPANIES

Shaping  
the future  
of surgery

035213-151006



# Products by category

At Ethicon, we develop meaningful solutions that enhance surgical outcomes and improve the lives of patients. For more than 80 years, we have listened to the voice of our customers, working in partnership with clinicians, hospitals, payors, and other healthcare stakeholders to gain deep experience and perspective into ways to redefine surgery. Our global scope, along with our broad surgical portfolio, let us provide market-appropriate, value-driven solutions that help patients around the world live longer, healthier lives. Also available, are our 'Online Product Solutions' - [ethicon.com/ops](http://ethicon.com/ops)

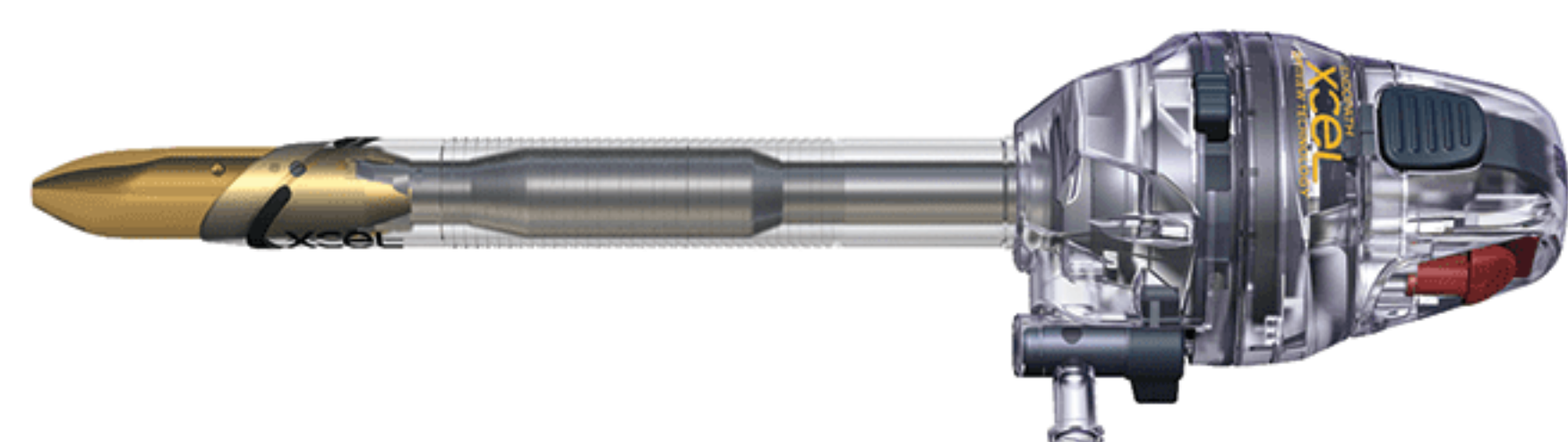

3

## Access

Ethicon offers you flexibility across surgical specialties, so you can choose the right trocar, with the right level of performance, when and where it is needed. The ENDOPATH® Trocar Portfolio brings value to every procedure.



10

## Advanced Energy

With the broadest advanced energy portfolio, Ethicon provides you with unmatched choice for your laparoscopic and open surgical needs. HARMONIC® Ultrasonic devices offer precision, multi-functionality and strong vessel sealing. ENSEAL® Advanced Bipolar devices bring confidence and consistency to vessel sealing and deliver versatility in every device.



16

## Hernia Repair & Fixation

Ethicon has been pioneering advances in hernia surgery to help restore patients back to their pre-hernia life. The Ethicon portfolio offers choice to ensure you have the right solutions for the right procedure. Our innovative, value-led solutions provide strong and safe hernia repair and are designed to improve long-term patient outcomes.



23

## Ligation

The Ethicon portfolio of endoscopic and open ligation devices are designed to provide optimal patient surgical experiences. Our deep understanding of the interaction between surgical tools and living tissue has enabled us to design solutions for confident occlusion.



26

## Surgical Stapling

Reliable tissue repair is a critical factor for all surgery. That's why Ethicon has worked with surgeons worldwide to develop and refine our surgical staplers and cutters. Our surgical stapling portfolio addresses the issues of tissue thickness, staple line security, and tissue tension to provide you solutions that are designed to enhance control and patient safety.



36

## Uterine & Pelvic Surgery

Ethicon has worked with gynecologists to create innovative new solutions for a greater choice of procedure. Plus, we've aligned our portfolio to the surgical treatment pathway so you can ensure you have the right solutions for the right procedure. Enhanced technique combined with innovative technologies helps to improve surgical performance.



39

## Wound Closure

Secure skin closure is an integral part of nearly every surgical procedure. Ethicon has pioneered advances in skin closure that enable you to minimize tissue trauma, optimize healing, and improve patient outcomes. We offer a portfolio of innovative wound closure solutions designed for the specific needs of skin, fascia, and organ tissues.



46

## Other Devices

Whatever your needs during the course of surgery, Ethicon is committed to providing you a solution. From laparoscopic hand instruments to gastric banding, drains, and reservoirs, you can count us to provide you with outstanding value, excellent service, and a broad range of product offerings.



# Access

Ethicon offers you flexibility across surgical specialties, so you can choose the right trocar, with the right level of performance, when and where it is needed. The ENDOPATH® Trocar Portfolio brings value to every procedure.

<b>ENDOPATH XCEL® Bladeless Trocars with OPTIVIEW® Technology</b> 5mm, 12mm	PRODUCT CODE	SHAFT DIAMETER	SHAFT LENGTH	SLEEVE	EA / BX
	2B5ST	5mm	75mm	Stability	6
	2B5LT	5mm	100mm	Stability	6
	2B5XT	5mm	150mm	Stability	6
	2B12LT	12mm	100mm	Stability	6
	2B12XT	12mm	150mm	Stability	6

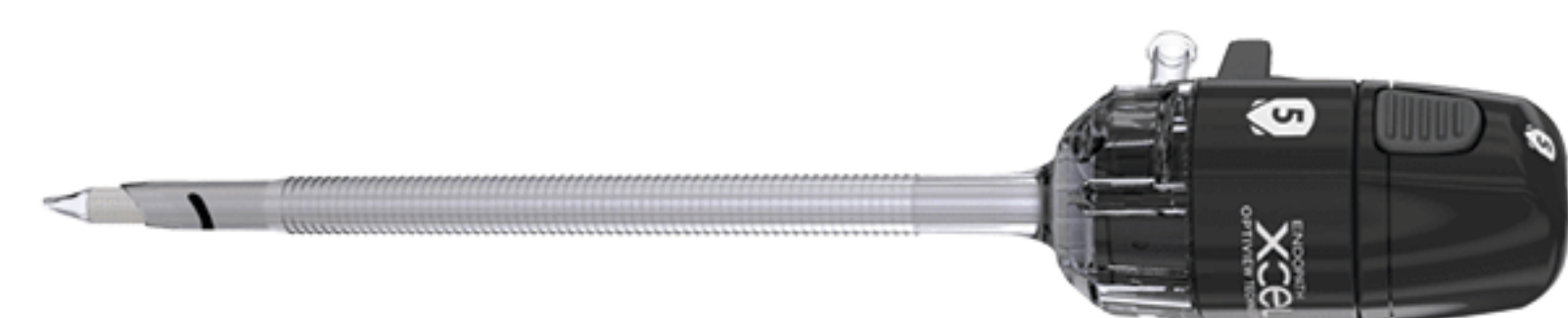

<b>ENDOPATH XCEL® Blunt Tip Trocar with OPTIVIEW® Technology</b> 12mm	PRODUCT CODE	SHAFT DIAMETER	SHAFT LENGTH	SLEEVE	EA / BX
	2H12LP	12mm	100mm	Stability	6

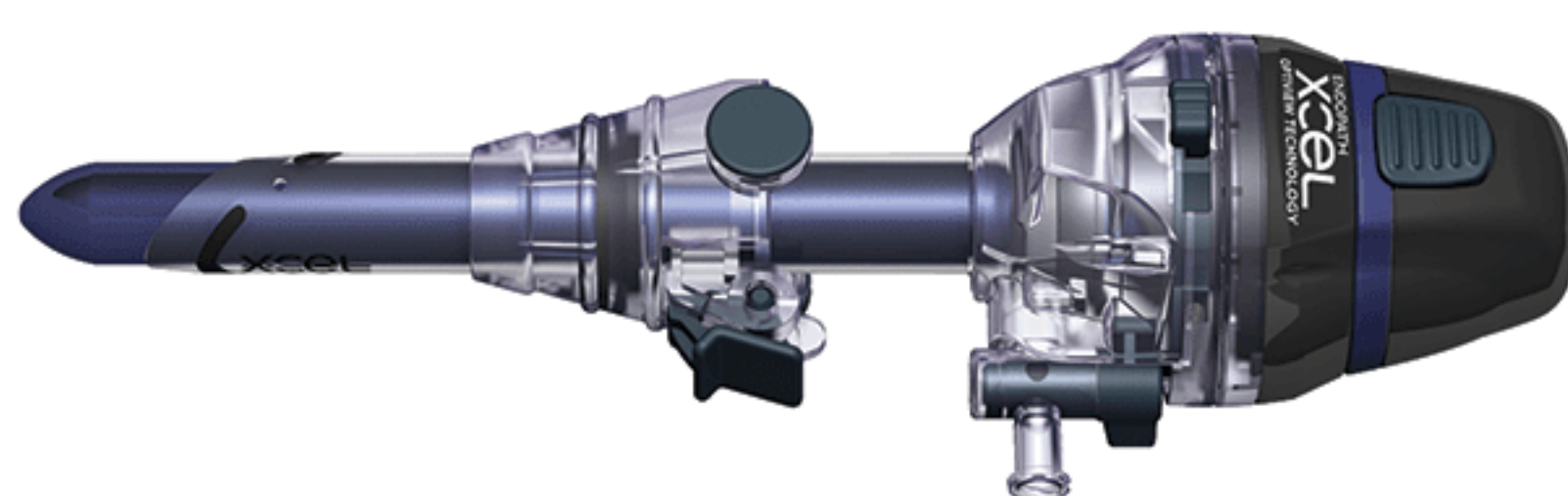

<b>ENDOPATH XCEL® Dilating Tip Trocars with OPTIVIEW® Technology</b> 5mm, 12mm	PRODUCT CODE	SHAFT DIAMETER	SHAFT LENGTH	SLEEVE	EA / BX
	2D5ST	5mm	75mm	Stability	6
	2D5LT	5mm	100mm	Stability	6
	2D12LT	12mm	100mm	Stability	6
	2D12XT	12mm	150mm	Stability	6

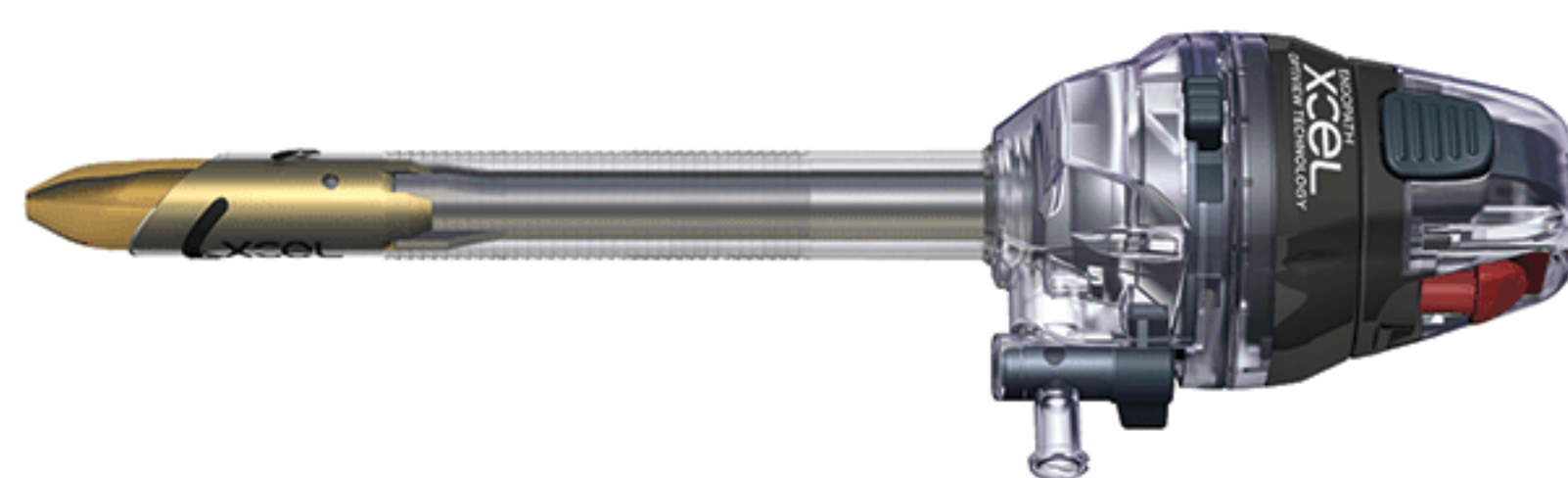

<b>ENDOPATH XCEL® Universal Sleeves with OPTIVIEW® Technology</b> 5mm, 12mm	PRODUCT CODE	SHAFT DIAMETER	SHAFT LENGTH	SLEEVE	EA / BX
	2CB5ST	5mm	75mm	Stability	6
	2CB5LT	5mm	100mm	Stability	6
	2CB12LT	12mm	100mm	Stability	6

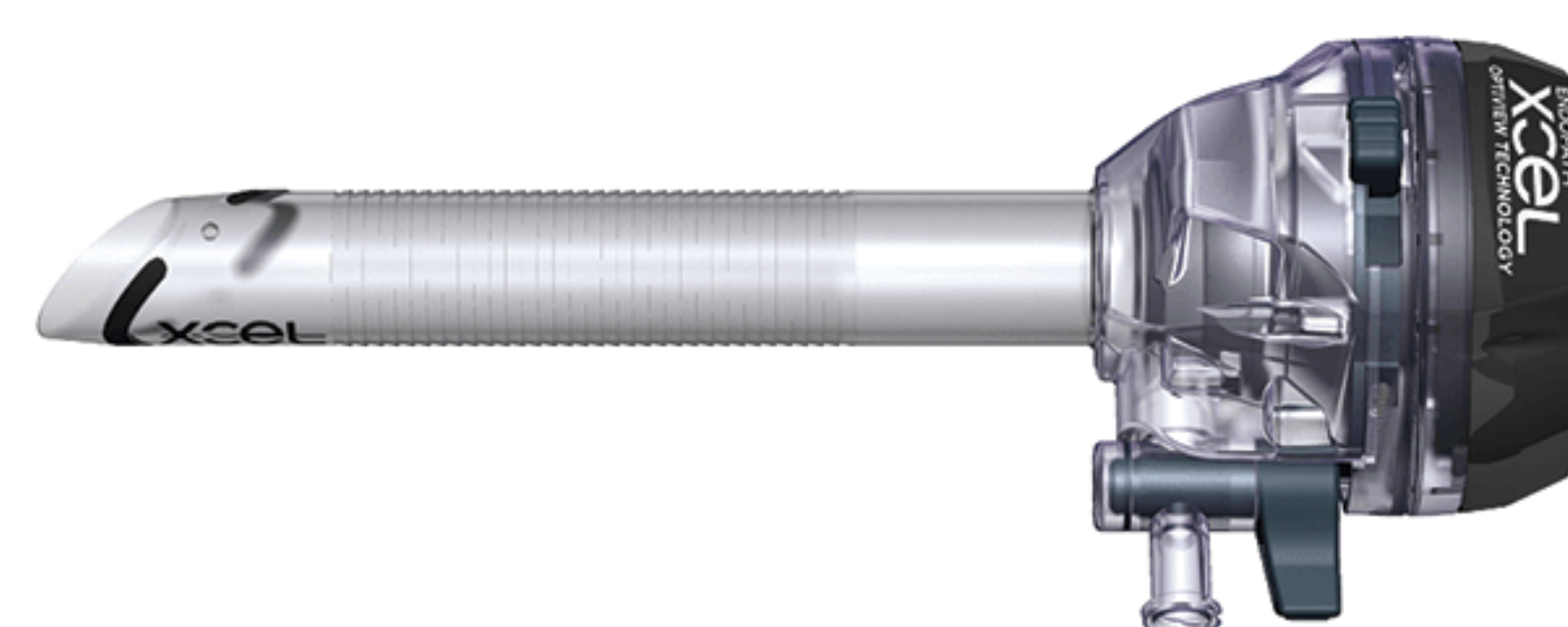



# Access

Ethicon offers you flexibility across surgical specialties, so you can choose the right trocar, with the right level of performance, when and where it is needed. The ENDOPATH® Trocar Portfolio brings value to every procedure.

ENDOPATH XCEL® Bladeless Trocars 5mm, 8mm, 11mm, 12mm, 15mm	PRODUCT CODE	SHAFT DIAMETER	SHAFT LENGTH	SLEEVE	EA / BX
		B5ST	5mm	75mm	Stability
	B5LT	5mm	100mm	Stability	6
	B5XT	5mm	150mm	Stability	6
	B8LT	8mm	100mm	Stability	6
	B11LT	11mm	100mm	Stability	6
	B11LP	11mm	100mm	Smooth	6
	B11LTH	11mm	100mm, handled	Stability	6
	B11LPH	11mm	100mm, handled	Smooth	6
	B12SRT	12mm	75mm	Stability	6
	B12LT	12mm	100mm	Stability	6
	B12LP	12mm	100mm	Smooth	6
	B12LTH	12mm	100mm, handled	Stability	6
	B12LPH	12mm	100mm, handled	Smooth	6
	B12XT	12mm	150mm	Stability	6
	B15LT	15mm	100mm	Stability	6

ENDOPATH XCEL® Dilating Tip Trocars 5mm, 11mm, 12mm	PRODUCT CODE	SHAFT DIAMETER	SHAFT LENGTH	SLEEVE	EA / BX
		D5ST	5mm	75mm	Stability
	D5LT	5mm	100mm	Stability	6
	D11LT	11mm	100mm	Stability	6
	D12LT	12mm	100mm	Stability	6
	D12XT	12MM	150mm	Stability	6

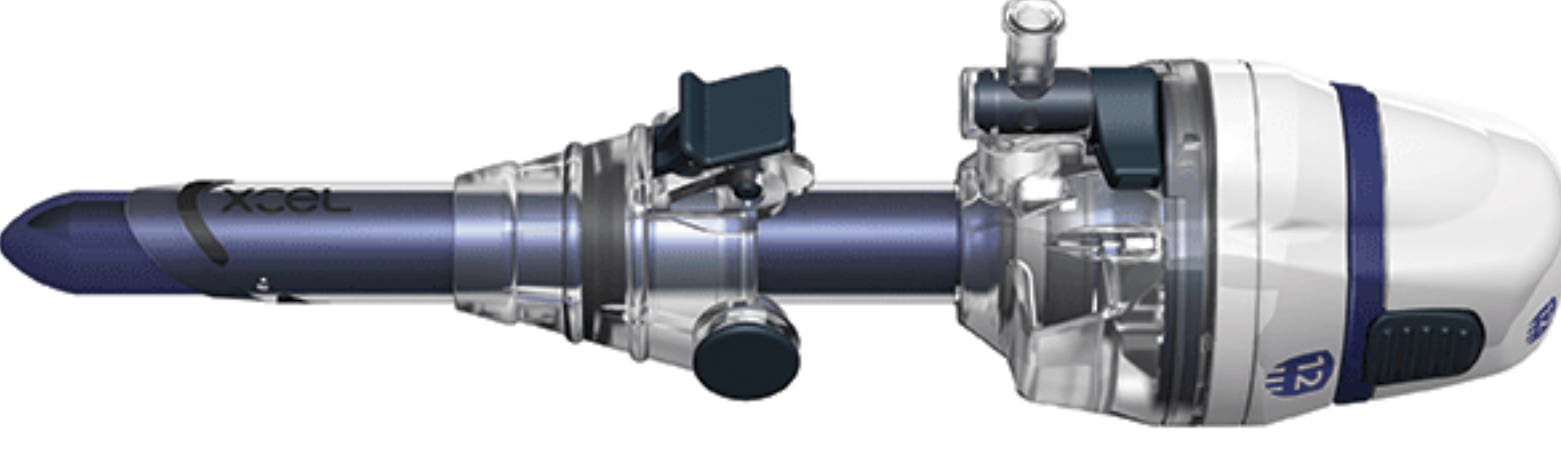
ENDOPATH XCEL® Blunt Tip Trocar 12mm	PRODUCT CODE	SHAFT DIAMETER	SHAFT LENGTH	SLEEVE	EA / BX
		H12LP	12mm	100mm	Smooth



# Access

Ethicon offers you flexibility across surgical specialties, so you can choose the right trocar, with the right level of performance, when and where it is needed. The ENDOPATH® Trocar Portfolio brings value to every procedure.

<b>ENDOPATH XCEL® Universal Sleeves</b> 5mm, 11mm, 12mm	PRODUCT CODE	SHAFT DIAMETER	SHAFT LENGTH	SLEEVE	EA / BX
	CB5ST	5mm	75mm	Stability	6
	CB5LT	5mm	100mm	Stability	6
	CB11LT	11mm	100mm	Stability	6
	CB12LT	12mm	100mm	Stability	6



<b>ENDOPATH BASX® Bladeless Trocars</b> 5mm, 11mm, 12mm	PRODUCT CODE	SHAFT DIAMETER	SHAFT LENGTH	SLEEVE	EA / BX
	TB5ST	5mm	75mm	Stability	6
	TB5LT	5mm	100mm	Stability	6
	TB11LT	11mm	100mm	Stability	6
	TB12ST	12mm	75mm	Stability	6
TB12LT	12mm	100mm	Stability	6	



<b>ENDOPATH BASX® Universal Sleeves</b> 5mm, 11mm, 12mm	PRODUCT CODE	SHAFT DIAMETER	SHAFT LENGTH	SLEEVE	EA / BX
	CTB5ST	5mm	75mm	Stability	6
	CTB5LT	5mm	100mm	Stability	6
	CTB11LT	11mm	100mm	Stability	6
	CTB12LT	12mm	100mm	Stability	6

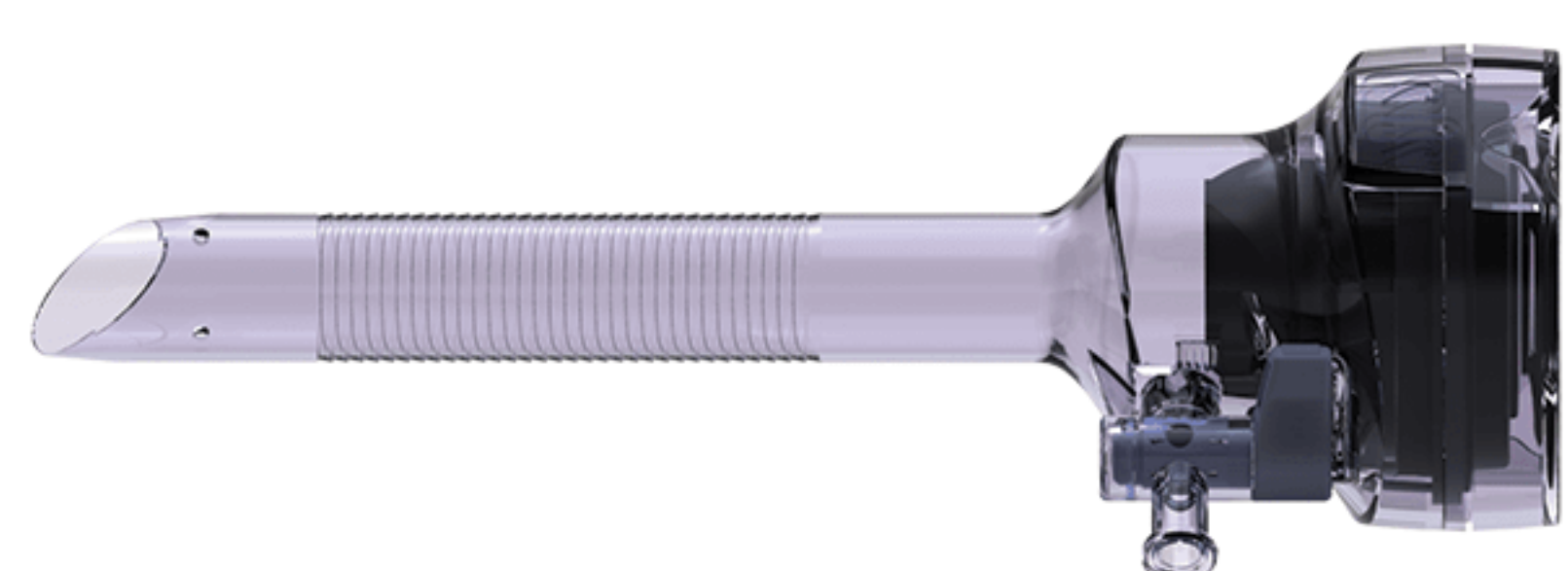

<b>ENDOPATH® Mini/Micro Trocars</b> Nonoptical 2mm / 3mm	PRODUCT CODE	SHAFT DIAMETER	SHAFT LENGTH	SLEEVE	EA / BX
	23NBS	2mm / 3mm	65mm	Smooth	6
	23NBL	2mm / 3mm	100mm	Smooth	6

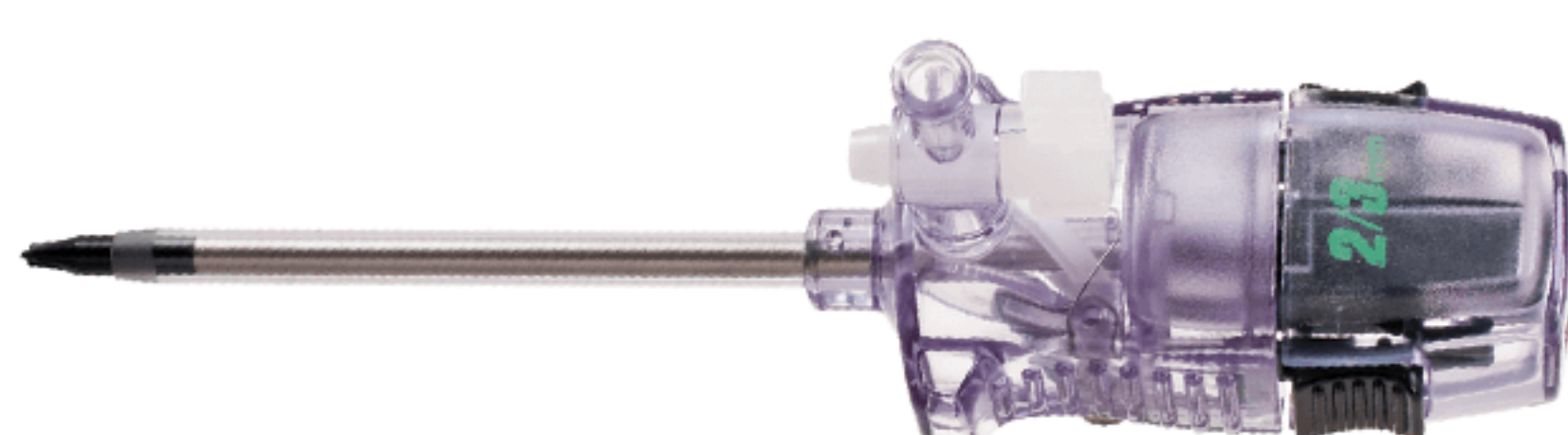





# Access

Ethicon offers you flexibility across surgical specialties, so you can choose the right trocar, with the right level of performance, when and where it is needed. The ENDOPATH® Trocar Portfolio brings value to every procedure.

<b>ENDOPATH® Non-Shielded Trocars</b> 5mm 	PRODUCT CODE	SHAFT DIAMETER	SHAFT LENGTH	SLEEVE	EA / BX
	355NS	5mm	65mm	Non-shielded	6
	35LNS	5mm	100mm	Non-shielded	6

<b>ENDOPATH® Rigid Thoracic Trocar</b> 10mm / 12mm 	PRODUCT CODE	SHAFT DIAMETER	SHAFT LENGTH	SLEEVE	EA / BX
	TT012	10mm / 12mm	75mm	Rigid	6

<b>FLEXIPATH® Flexible Thoracic Trocars</b> 	PRODUCT CODE	SHAFT DIAMETER	SHAFT LENGTH	SLEEVE	EA / BX
	FP007	7mm	80mm	Flexible	6
	FP015	15mm	80mm	Flexible	6
	FP020	20mm	80mm	Flexible	6





# Access

Ethicon offers you flexibility across surgical specialties, so you can choose the right trocar, with the right level of performance, when and where it is needed. The ENDOPATH® Trocar Portfolio brings value to every procedure.

<b>FLEXIPATH® Flexible Thoracic Trocar Pack</b> 	PRODUCT CODE	DESCRIPTION	EA / BX
		FPK02	Contains: (1) 15mm obturator and (3) 15mm flexible sleeves

<b>ENDOPATH® Bladeless, Obturator and Housing - For use with ENDOPATH® Reusable Sleeves</b> 	PRODUCT CODE	SHAFT DIAMETER	SHAFT LENGTH	SLEEVE	EA / BX
	355NA	5mm	75mm	Reusable	6
	35LNA	5mm	100mm	Reusable	6
	511NA	10mm / 11mm	100mm	Reusable	6
	512NA	10mm / 12mm	100mm	Reusable	6

<b>ENDOPATH® Dilating Tip, Obturator and Housing - For use with ENDOPATH® Reusable Sleeves</b> 	PRODUCT CODE	SHAFT DIAMETER	SHAFT LENGTH	SLEEVE	EA / BX
	355DA	5mm	75mm	Reusable	6
	35LDA	5mm	100mm	Reusable	6
	511DA	10mm / 11mm	100mm	Reusable	6
	512DA	10mm / 12mm	100mm	Reusable	6

<b>ENDOPATH® Blunt Tip, Obturator, Housing and Olive Plug - For use with ENDOPATH® Reusable Sleeves</b> 	PRODUCT CODE	SHAFT DIAMETER	SHAFT LENGTH	SLEEVE	EA / BX
		512BA	10mm / 12mm	100mm	Reusable



# Access

Ethicon offers you flexibility across surgical specialties, so you can choose the right trocar, with the right level of performance, when and where it is needed. The new ENDOPATH® Trocar Portfolio brings value to every procedure.

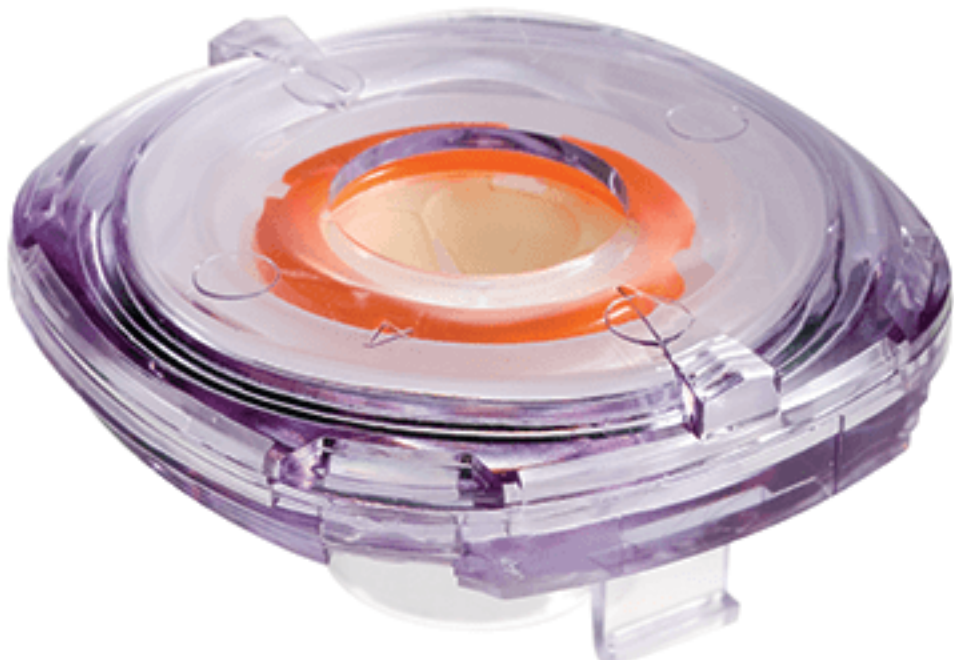
ENDOPATH® ONESEAL Reducer Cap	PRODUCT CODE	DIAMETER	EA / BX
		1SEAL	5 - 12mm

ENDOPATH® Disposable Housing Units	PRODUCT CODE	DIAMETER	EA / BX	
		355HR	5mm	6
	511HR	10/11mm	6	
	512HR	10/11mm	6	

ENDOPATH® Reusable Sleeves	PRODUCT CODE	SHAFT DIAMETER	SHAFT LENGTH	SLEEVE	EA / BX	
		355RT	5mm	75mm	Stability	1
	35LRT	5mm	100mm	Stability	1	
	511RT	10mm / 11mm	100mm	Stability	1	
	512RT	10mm / 12mm	100mm	Stability	1	



# Access

## HALS / Insufflation Needles

<b>ENDOPATH DEXTRUS® Minimally Invasive Access System</b>  	PRODUCT CODE	DESCRIPTION	ABDOMINAL WALL THICKNESS	EA / BX
	FLR01	Fixed-length access retractor - small	< 4cm	6
	FLR02	Fixed-length access retractor - medium	4 - 7cm	6
	FLR03	Fixed-length access retractor - larger	> 7cm	6
	HAP02	Seal cap assembly with accessories	N / A	3

<b>ENDOPATH® Insufflation Needles Pneumoperitoneum</b>  	PRODUCT CODE	SHAFT LENGTH	EA / BX
	PN120	120mm	12
	PN150	150mm	12

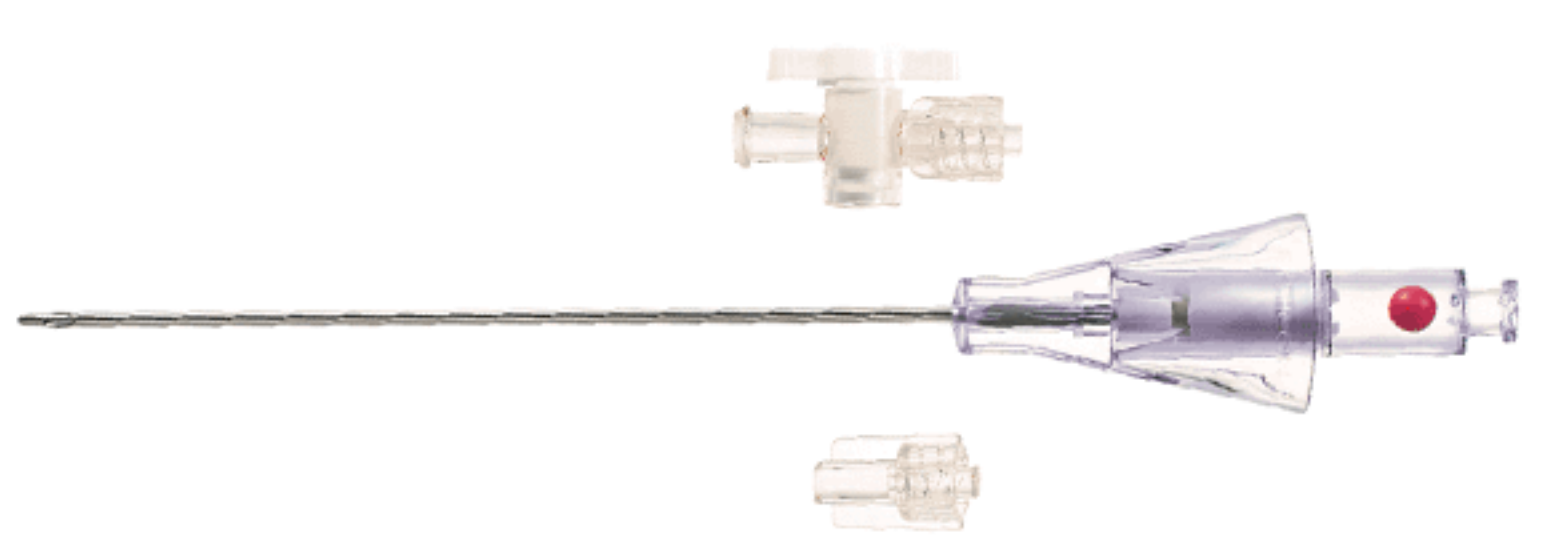
<b>ENDOPATH® Insufflation Needle Ultra Veress</b>  	PRODUCT CODE	SHAFT LENGTH	EA / BX
	UV120	120mm	12





# Advanced Energy

With the broadest advanced energy portfolio on the market today, Ethicon gives you solutions for laparoscopic and open procedures that combine performance and tissue protection. HARMONIC® Ultrasonic Devices let you handle multiple jobs with unsurpassed precision. ENSEAL® Advanced Bipolar Tissue Sealers give you superior seals.

<b>HARMONIC ACE®+7 Shears</b> 	PRODUCT CODE	SHAFT DIAMETER	SHAFT LENGTH	TIP	EA / BX
	HARH23	5mm	23cm	Curved	6
	HARH36	5mm	36cm	Curved	6
	HARH45	5mm	45cm	Curved	6

<b>HARMONIC ACE®+ Shears</b> 	PRODUCT CODE	SHAFT DIAMETER	SHAFT LENGTH	TIP	EA / BX
	HAR23	5mm	23cm	Curved	6
	HAR36	5mm	36cm	Curved	6

<b>HARMONIC ACE® Shears</b> 	PRODUCT CODE	SHAFT DIAMETER	SHAFT LENGTH	TIP	EA / BX
	ACE14S	5mm	14cm	Curved	6

<b>HARMONIC FOCUS®+ Shears</b> 	PRODUCT CODE	LENGTH	TIP	EA / BX
	HAR9F	9cm	Curved	6

<b>HARMONIC FOCUS® Long Curved Shears</b> 	PRODUCT CODE	LENGTH	TIP	EA / BX
	FCS17	17cm	Curved	6





# Advanced Energy

With the broadest advanced energy portfolio on the market today, Ethicon gives you solutions for laparoscopic and open procedures that combine performance and tissue protection. HARMONIC® Ultrasonic Devices let you handle multiple jobs with unsurpassed precision. ENSEAL® Advanced Bipolar Tissue Sealers give you superior seals.

<b>HARMONIC WAVE® Open Shears</b> 	PRODUCT CODE	SHAFT LENGTH	TIP	EA / BX
		WAVE18S	18cm	Straight

<b>HARMONIC SYNERGY® Blades</b> 	PRODUCT CODE	SHAFT LENGTH	HAND PIECE	TIP	EA / BX
	SNGCB	Adjustable 4 - 9cm	HPBLUE	Curved	6
	SNGHK	Adjustable 4 - 9cm	HPBLUE	Hook	6
	SNGHK2	Adjustable 4 - 9cm	HPBLUE	Combination Hook	6

<b>HARMONIC® Blades</b> 	PRODUCT CODE	SHAFT DIAMETER	SHAFT LENGTH	TIP	EA / BX
	HC325	5mm	32cm	Curved	6
	HDH05	5mm	32cm	Hook	6
	HBC05	5mm	31cm	Ball	6

<b>HARMONIC® Hand Piece</b> 	PRODUCT CODE	COMPATIBLE WITH	EA / BX
	HP054	ACE14S, HAR23, HAR36, HARH23, HARH36, HARH45, HBC05, HC325, HDH05, WAVE18S	1

<b>HARMONIC® BLUE Hand Piece</b> 	PRODUCT CODE	COMPATIBLE WITH	EA / BX
	HPBLUE	FCS17, HAR9F, SNGCB, SNGHK, SNGHK2	1





# Advanced Energy

With the broadest advanced energy portfolio on the market today, Ethicon gives you solutions for laparoscopic and open procedures that combine performance and tissue protection. HARMONIC® Ultrasonic Devices let you handle multiple jobs with unsurpassed precision. ENSEAL® Advanced Bipolar Tissue Sealers give you superior seals.

HARMONIC® Accessories		
PRODUCT CODE	DESCRIPTION	EA / BX
HAOSSL	HARMONIC ACE® 5mm open sleeve	6
HP54CTA	HARMONIC® Hand Piece cleaning tool	1
HSA08	Disposable hand switch adapter (only use with HP054)	3
HST01	Sterilization tray	1
HST02	Test tip for HP054	1
TLB01	Torque lock blade wrench	2
TTBLUE	Test tip for HPBLUE	1

<b>ENSEAL® G2 Articulating Tissue Sealers</b> 	PRODUCT CODE	SHAFT DIAMETER	SHAFT LENGTH	JAW	EA / BX
	NSLG2C35A	5mm	35cm	Curved	6
	NSLG2C45A	5mm	45cm	Curved	6
	NSLG2S35A	5mm	35cm	Straight	6
	NSLG2S45A	5mm	45cm	Straight	6

<b>ENSEAL® G2 Curved Tissue Sealers</b> 	PRODUCT CODE	SHAFT DIAMETER	SHAFT LENGTH	JAW	EA / BX
	NSLG2C14	5mm	14cm	Curved	6
	NSLG2C25	5mm	25cm	Curved	6
	NSLG2C35	5mm	35cm	Curved	6
	NSLG2C45	5mm	45cm	Curved	6

<b>ENSEAL® G2 Straight Tissue Sealers</b> 	PRODUCT CODE	SHAFT DIAMETER	SHAFT LENGTH	JAW	EA / BX
	NSLG2S14	5mm	14cm	Straight	6
	NSLG2S25	5mm	25cm	Straight	6
	NSLG2S35	5mm	35cm	Straight	6
	NSLG2S45	5mm	45cm	Straight	6





# Advanced Energy

With the broadest advanced energy portfolio on the market today, Ethicon gives you solutions for laparoscopic and open procedures that combine performance and tissue protection. HARMONIC® Ultrasonic Devices let you handle multiple jobs with unsurpassed precision. ENSEAL® Advanced Bipolar Tissue Sealers give you superior seals.

ENSEAL® G2 Super Jaw Tissue Sealer	PRODUCT CODE	SHAFT DIAMETER	SHAFT LENGTH	JAW	EA / BX
		NSEALX22L	12mm	22cm	40mm Curved

ENSEAL® Trio Tissue Sealers	PRODUCT CODE	SHAFT DIAMETER	SHAFT LENGTH	JAW	EA / BX	
		ETRIO314H	5mm	14cm	Curved	6
	ETRIO325H	5mm	25cm	Curved	6	
	ETRIO335H	5mm	35cm	Curved	6	
	ETRIO345H	5mm	45cm	Curved	6	

ENSEAL® Round Tip Tissue Sealers	PRODUCT CODE	SHAFT DIAMETER	SHAFT LENGTH	JAW	EA / BX	
		NSEAL514RH	5mm	14cm	Straight	6
	NSEAL525RH	5mm	25cm	Straight	6	
	NSEAL535RH	5mm	35cm	Straight	6	
	NSEAL545RH	5mm	45cm	Straight	6	

ETHICON ENDO-SURGERY™ Generator	PRODUCT CODE	COMPATIBLE WITH	EA / BX
		GEN11	All HARMONIC® and ENSEAL® devices



# Advanced Energy

With the broadest advanced energy portfolio on the market today, Ethicon gives you solutions for laparoscopic and open procedures that combine performance and tissue protection. HARMONIC® Ultrasonic Devices let you handle multiple jobs with unsurpassed precision. ENSEAL® Advanced Bipolar Tissue Sealers give you superior seals.

ETHICON ENDO-SURGERY™ Generator Accessories	PRODUCT CODE	DESCRIPTION	COMPATIBLE WITH	EA / BX
	HGA11	HARMONIC® connector	HP054 and HPBLUE hand pieces	1
	EGA11	ENSEAL® connector	ENSEAL® Trio Tissue Sealer and ENSEAL® Round Tip Tissue Sealer	1
	GEN11VK	Output verification key	GEN11	1
	FSW11	Foot switch and cable	GEN11	1
	CRT11	Generator cart	GEN11	1

ETHICON ENDO-SURGERY™ Generator Extended Warranty		
PRODUCT CODE	DESCRIPTION	EA / BX
GEN11WAR1	1 - Year extended warranty	1
GEN11WAR2	2- Year extended warranty	1





# Hernia Repair & Fixation

Ethicon has been pioneering advances in hernia surgery to help restore patients back to their pre-hernia life. The Ethicon portfolio offers choice to ensure you have the right solutions for the right procedure. Our innovative, value-led solutions provide strong and safe hernia repair and are designed to improve long-term patient outcomes.

PROLENE® Polypropylene Mesh	PRODUCT CODE	DESCRIPTION	SIZE	EA / BX
		PMH	Square	6" x 6" (15cm x 15cm)
PMII		Rectangle	3" x 6" (8cm x 15cm)	6
PML		Square	12" x 12" (30cm x 30cm)	3
PMLK		Large pre-shaped keyhole	2.4" x 5.4" (6cm x 13.7cm)	6
PMSK		Small pre-shaped keyhole	1.8" x 4.0" (4.6cm x 10cm)	3
PMXL		Rectangle	2" x 12" (5cm x 30cm)	6
PMXS		Rectangle	1" x 4" (2.54cm x 10cm)	6

PROLENE® Soft Polypropylene Mesh	PRODUCT CODE	DESCRIPTION	SIZE	EA / BX
		SPMXS	Rectangle	1" x 4" (2.54cm x 10cm)
SPMS		Rectangle	2" x 4" (5cm x 10cm)	6
SPMII		Rectangle	3" x 6" (7.6cm x 15cm)	6
SPMH		Square	6" x 6" (15cm x 15cm)	6
SPMLI		Square	10" x 10" (25cm x 25cm)	3
SPMXXL		Rectangle	14" x 12" (35.6cm x 30cm)	3

MERSILENE™ Polyester Fiber Mesh	PRODUCT CODE	DESCRIPTION	SIZE	EA / BX
		RMS	Rectangle	2.5" x 4.5" (6cm x 11cm)
RML		Square	12" x 12" (30cm x 30cm)	3

ULTRAPRO® Partially Absorbable Lightweight Mesh	PRODUCT CODE	DESCRIPTION	SIZE	EA / BX
		UMS3	Rectangle	2.4" x 4.3" (6cm x 11cm)
UMR3		Rectangle	3" x 6" (7.6cm x 15cm)	3
UMM3		Square	6" x 6" (15cm x 15cm)	3
UML1		Square	12" x 12" (30cm x 30cm)	1



# Hernia Repair & Fixation

Ethicon has been pioneering advances in hernia surgery to help restore patients back to their pre-hernia life. The Ethicon portfolio offers choice to ensure you have the right solutions for the right procedure. Our innovative, value-led solutions provide strong and safe hernia repair and are designed to improve long-term patient outcomes.

<b>VICRYL® (polyglactin 910) Knitted Mesh</b> <b>VICRYL® (polyglactin 910) Woven Mesh</b> 	PRODUCT CODE	DESCRIPTION	SIZE	EA / BX
	VKML	Knitted	12" x 12" (30cm x 30cm)	3
	VKMM	Knitted	6" x 6" (15cm x 15cm)	3
	VWML	Woven	12" x 12" (30cm x 30cm)	3
	VWMM	Woven	6" x 6" (15cm x 15cm)	3

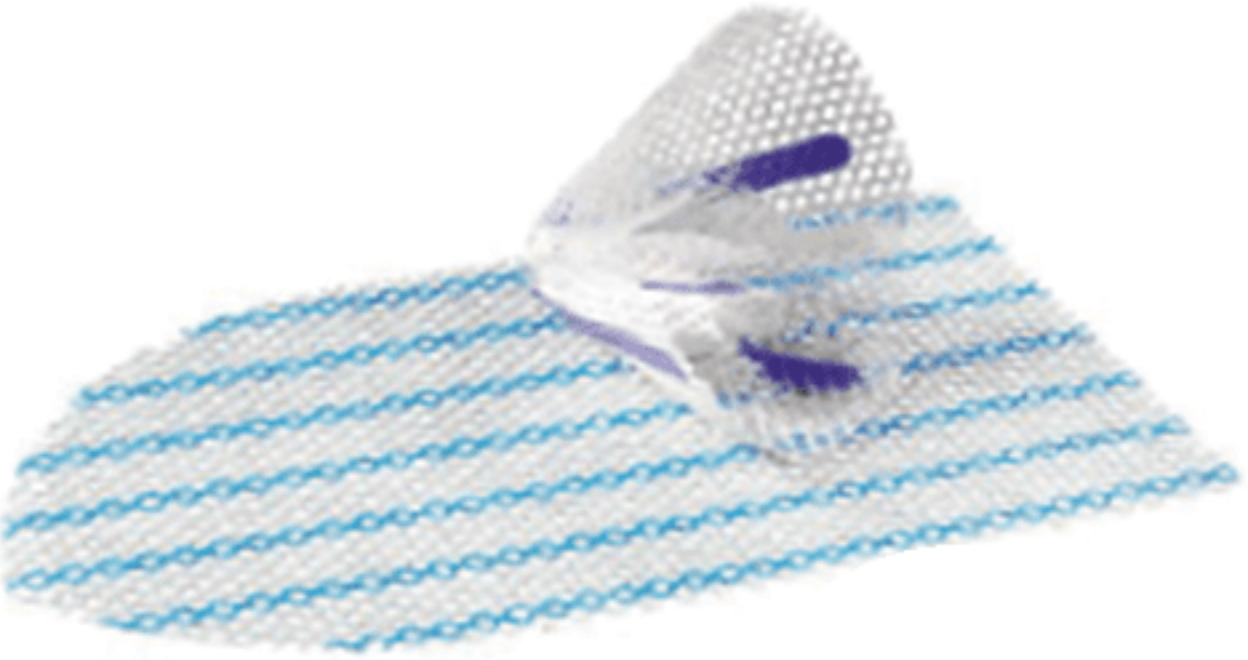
<b>ULTRAPRO® COMFORT PLUG™ Partially Absorbable Hernia Repair Device</b> 	PRODUCT CODE	PLUG DIAMETER	ONLAY MESH SIZE	EA / BX
	UPLUG401	40mm	7cm x 14cm	1
	UPLUG403	40mm	7cm x 14cm	3
	UPLUG406	40mm	7cm x 14cm	6
	UPLUG551	55mm	7cm x 14cm	1
	UPLUG553	55mm	7cm x 14cm	3
UPLUG556	55mm	7cm x 14cm	6	

<b>PROLENE® Polypropylene Hernia System</b> 	PRODUCT CODE	DESCRIPTION	UNDERLAY PATCH SIZE	ONLAY PATCH SIZE	CONNECTOR SIZE	EA / BX
	PHSM	Medium	7cm	4.5cm x 10cm	1.9cm x 1.3cm	1
	PSHM6	Medium	7cm	4.5cm x 10cm	1.9cm x 1.3cm	3
	PHSL	Large	10cm	4.5cm x 10cm	1.9cm x 1.3cm	6
	PHSL6	Large	10cm	4.5cm x 10cm	1.9cm x 1.3cm	1
	PHSE	Extended	10cm	5.5cm x 12.8cm	1.9cm x 1.3cm	3
PHSE6	Extended	10cm	5.5cm x 12.8cm	1.9cm x 1.3cm	6	

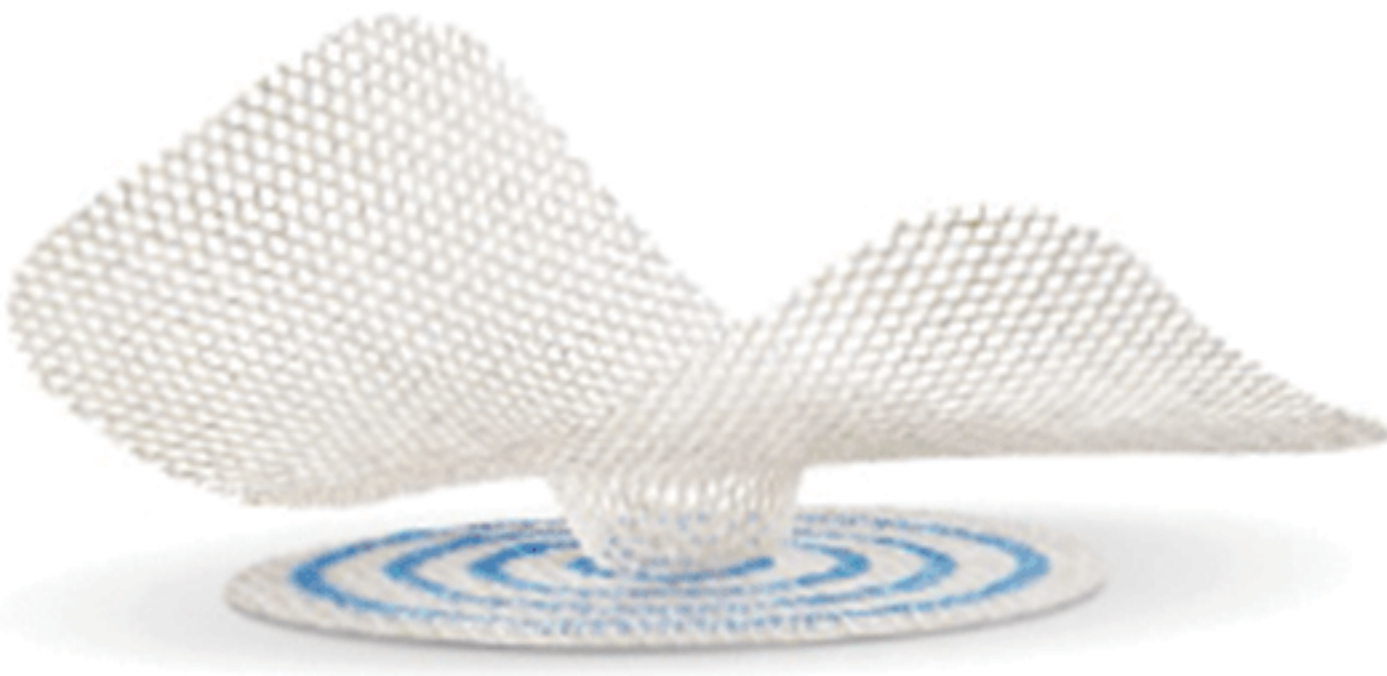
<b>ULTRAPRO® Hernia System</b> 	PRODUCT CODE	DESCRIPTION	UNDERLAY PATCH SIZE	ONLAY PATCH SIZE	EA / BX
	UHSM	Medium	6cm x 12cm	7.5cm	3
	UHSM6	Medium	6cm x 12cm	7.5cm	6
	UHSL	Large	6cm x 12cm	-10cm	3
	UHSL6	Large	6cm x 12cm	-10cm	6
	UHSOV	Oval	6cm x 12cm	-10cm x 12cm	3



# Hernia Repair & Fixation

Ethicon has been pioneering advances in hernia surgery to help restore patients back to their pre-hernia life. The Ethicon portfolio offers choice to ensure you have the right solutions for the right procedure. Our innovative, value-led solutions provide strong and safe hernia repair and are designed to improve long-term patient outcomes.

PROCEED® Surgical Mesh	PRODUCT CODE	DESCRIPTION	SIZE	EA / BX
	PCDB1	Rectangle	5cm x 10cm	1
PCDR1	Rectangle	7.5cm x 15cm	1	
PCDN1	Oval	10cm x 15cm	1	
PCDM1	Square	15cm x 15cm	1	
PCDD1	Rectangle	10cm x 20cm	1	
PCDG1	Oval	15cm x 20cm	1	
PCDH1	Oval	20cm x 25cm	1	
PCDJ1	Rectangle	20cm x 30cm	1	
PCDT1	Oval	26cm x 34cm	1	
PCDW1	Rectangle	25cm x 35.5cm	1	
PCDLW	Square	30.5cm x 30.5cm	1	



ETHICON PHYSIOMESH® Flexible Composite Mesh	PRODUCT CODE	DESCRIPTION	SIZE	EA / BX
	PHY0715R	Rectangle	7cm x 15cm	1
PHY1015V	Oval	10cm x 15cm	1	
PHY1515Q	Square	15cm x 15cm	1	
PHY1520R	Rectangle	15cm x 20cm	1	
PHY1520V	Oval	15cm x 20cm	1	
PHY2025V	Oval	20cm x 25cm	1	
PHY2030R	Rectangle	20cm x 30cm	1	
PHY2535V	Oval	25cm x 25cm	1	
PHY3035R	Rectangle	30cm x 35cm	1	
PHY3050R	Rectangle	30cm x 50cm	1	

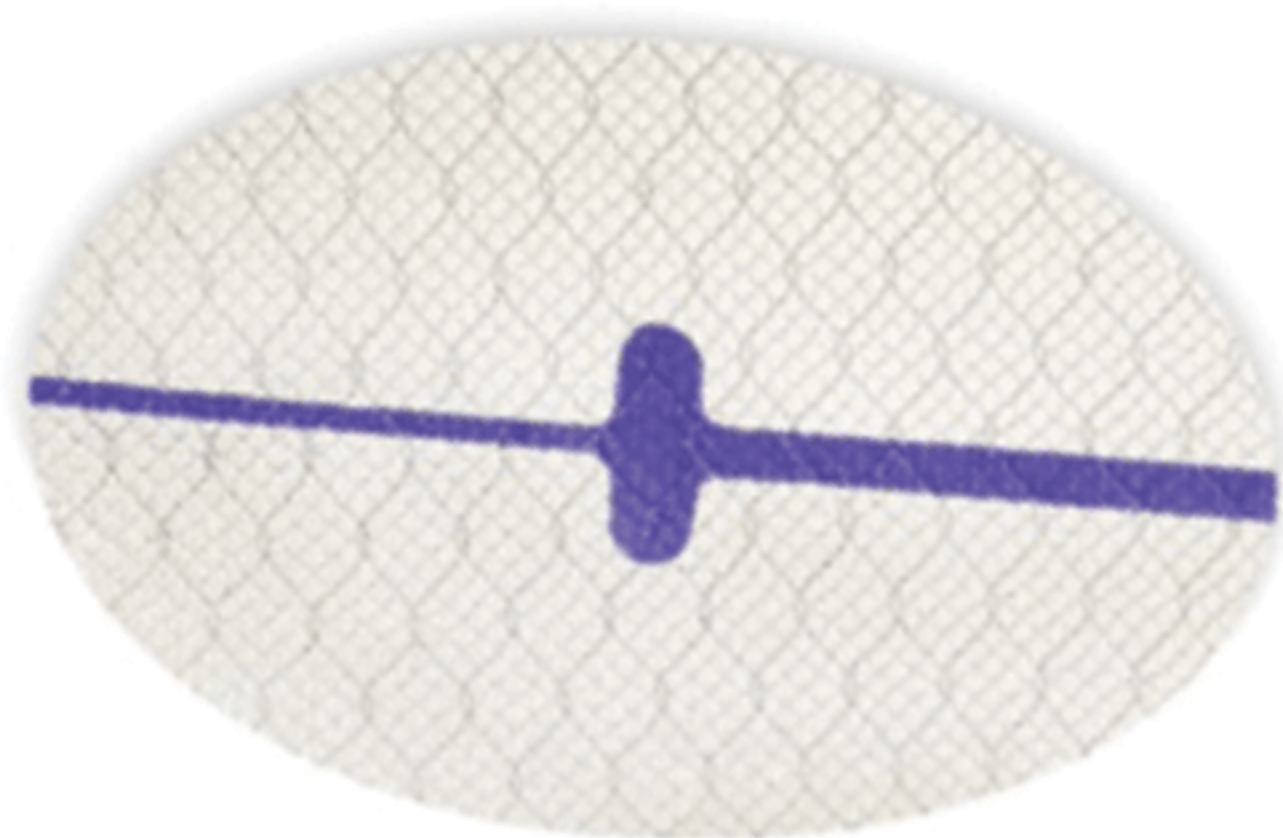

PROCEED® Ventral Patch	PRODUCT CODE	DESCRIPTION	SIZE	EA / BX
	PVPS	Circle	4.3cm x 4.3cm	2
PVPM	Circle	6.4cm x 6.4cm	2	





# Hernia Repair & Fixation

Ethicon has been pioneering advances in hernia surgery to help restore patients back to their pre-hernia life. The Ethicon portfolio offers choice to ensure you have the right solutions for the right procedure. Our innovative, value-led solutions provide strong and safe hernia repair and are designed to improve long-term patient outcomes.

FlexHD® Structural Acellular Hydrated Dermis (allograft)	PRODUCT CODE	THICKNESS	DIMENSIONS	EA / BX
	470407	0.4mm - 0.8mm	4cm x 7cm	1
	471407	0.8mm - 1.7mm	4cm x 7cm	1
	471608	0.8mm - 1.7mm	6cm x 8cm	1
	471812	0.8mm - 1.7mm	8cm x 12cm	1
	471122	0.8mm - 1.7mm	12cm x 12cm	1
	471016	0.8mm - 1.7mm	10cm x 16cm	1
	471216	0.8mm - 1.7mm	12cm x 16cm	1
	471220	0.8mm - 1.7mm	12cm x 20cm	1
	471620	0.8mm - 1.7mm	16cm x 20cm	1
	471202	0.8mm - 1.7mm	20cm x 20cm	1
	471224	0.8mm - 1.7mm	12cm x 24cm	1
	471225	0.8mm - 1.7mm	20cm x 25cm	1
	471230	0.8mm - 1.7mm	20cm x 30cm	1
	472812	1.8mm - 4mm	8cm x 12cm	1
	472122	1.8mm - 4mm	12cm x 12cm	1
	472016	1.8mm - 4mm	10cm x 16cm	1
	472216	1.8mm - 4mm	12cm x 16cm	1
	472220	1.8mm - 4mm	12cm x 20cm	1
	472620	1.8mm - 4mm	16cm x 20cm	1
	472202	1.8mm - 4mm	20cm x 20cm	1
472224	1.8mm - 4mm	12cm x 24cm	1	
472225	1.8mm - 4mm	20cm x 25cm	1	
472230	1.8mm - 4mm	20cm x 30cm	1	



# Hernia Repair & Fixation

Ethicon has been pioneering advances in hernia surgery to help restore patients back to their pre-hernia life. The Ethicon portfolio offers choice to ensure you have the right solutions for the right procedure. Our innovative, value-led solutions provide strong and safe hernia repair and are designed to improve long-term patient outcomes.

<b>FlexHD® Diamond XL Acellular Hydrated Dermis (allograft)</b> 	PRODUCT CODE	THICKNESS	DIMENSIONS	EA / BX
	4D1331	0.8mm - 1.7mm	22cm x 30cm	1
	4D1335	0.8mm - 1.7mm	24cm x 35cm	1
	4D2331	1.8mm - 4mm	22cm x 30cm	1
	4D2335	1.8mm - 4mm	24cm x 35cm	1

<b>XCM BIOLOGIC® Tissue Matrix (xenograft) - hydrated</b> 	PRODUCT CODE	THICKNESS	DIMENSIONS	EA / BX
	XM106.0612S	1.5mm ± 0.3mm	6cm x 12cm	1
	XM106.0616S	1.5mm ± 0.3mm	6cm x 16cm	1
	XM106.0812S	1.5mm ± 0.3mm	8cm x 12cm	1
	XM106.0816S	1.5mm ± 0.3mm	8cm x 16cm	1
	XM106.0820S	1.5mm ± 0.3mm	8cm x 20cm	1
	XM106.1016S	1.5mm ± 0.3mm	10cm x 16cm	1
	XM106.1020S	1.5mm ± 0.3mm	10cm x 20cm	1
	XM106.1220S	1.5mm ± 0.3mm	12cm x 20cm	1
	XM106.1620S	1.5mm ± 0.3mm	16cm x 20cm	1
	XM106.1625S	1.5mm ± 0.3mm	16cm x 25cm	1
	XM106.2020S	1.5mm ± 0.3mm	20cm x 20cm	1
	XM106.2025S	1.5mm ± 0.3mm	20cm x 25cm	1
	XM106.2030S	1.5mm ± 0.3mm	20cm x 30cm	1
	XM106.2040S	1.5mm ± 0.3mm	20cm x 40cm	1
	XM106.2540S	1.5mm ± 0.3mm	25cm x 40cm	1
	XM106.2545S	1.5mm ± 0.3mm	25cm x 45cm	1

<b>XCM BIOLOGIC® Tissue Matrix, Tailored Coverage™, Thick</b>	PRODUCT CODE	THICKNESS	DIMENSIONS	EA / BX
	XM106.2535TCS	1.5mm ± 0.3mm	25cm x 35cm	1



# Hernia Repair & Fixation

Ethicon has been pioneering advances in hernia surgery to help restore patients back to their pre-hernia life. The Ethicon portfolio offers choice to ensure you have the right solutions for the right procedure. Our innovative, value-led solutions provide strong and safe hernia repair and are designed to improve long-term patient outcomes.

<b>ETHICON SECURESTRAP® Absorbable Strap Fixation Device</b>  	PRODUCT CODE	DESCRIPTION	EA / BX
	STRAP12	5mm single use device with 12 absorbable straps	6
	STRAP25	5mm single use device with 25 absorbable straps	6

<b>ETHICON SECURESTRAP® Open Absorbable Strap Fixation Device</b>  	PRODUCT CODE	DESCRIPTION	EA / BX
	OPENSTRAP20	Single use device with 20 absorbable straps	6





# Ligation

The Ethicon portfolio of endoscopic and open ligation devices are designed to provide optimal patient surgical experiences. Our deep understanding of the interaction between surgical tools and living tissue has enabled us to design solutions for confident occlusion.

LIGAMAX™ 5 Endoscopic Clip Applier	PRODUCT CODE	SHAFT DIAMETER	CLIP SIZE	NUMBER OF CLIPS	EA / BX
		EL5ML	5mm	Medium / Large	15

10mm LIGACLIP® Endoscopic Rotating Multiple-Clip Applier	PRODUCT CODE	SHAFT DIAMETER	CLIP SIZE	NUMBER OF CLIPS	EA / BX
		ER320	10mm	Medium / Large	20

12mm LIGACLIP® Endoscopic Rotating Multiple-Clip Applier	PRODUCT CODE	SHAFT DIAMETER	CLIP SIZE	NUMBER OF CLIPS	EA / BX
		ER420	12mm	Large	20

LIGACLIP® Endoscopic Clip Applier	PRODUCT CODE	CLIP SIZE	EA / BX	
		EL214	Medium	1
	EL314	Medium / Large	1	
	EL414	Large	1	



# Ligation

The Ethicon portfolio of endoscopic and open ligation devices are designed to provide optimal patient surgical experiences. Our deep understanding of the interaction between surgical tools and living tissue has enabled us to design solutions for confident occlusion.

<b>LIGACLIP® Multi-Clip Appliers (MCA)</b> 	PRODUCT CODE	SHAFT LENGTH	CLIP SIZE	NUMBER OF CLIPS	EA / BX
	MCS20	9 3/8"	Small	20	6
	MSM20	9 3/8"	Medium	20	6
	MCM20	11"	Medium	20	6
	MCM30	11"	Medium	30	6
	MCL20	13"	Large	20	6

<b>LIGACLIP® Multi-Patient Single-Clip Applier - Blue</b> 	PRODUCT CODE	LENGTH	HANDLE COLOR	CLIP SIZE	SPECIFICATION	EA / BX
	LX105	5 3/4"	Blue	Small	-	1
	LX107	7 1/2"	Blue	Small	-	1
	LX110	10 1/2"	Blue	Small	-	1
	LX130	10 1/2"	Blue	Small	Right angle	1

<b>LIGACLIP® Multi-Patient Single-Clip Applier - Silver</b> 	PRODUCT CODE	LENGTH	HANDLE COLOR	CLIP SIZE	SPECIFICATION	EA / BX
	LX205	5 3/4"	Silver	Medium	-	1
	LX207	7 1/2"	Silver	Medium	-	1
	LX210	10 1/2"	Silver	Medium	-	1
	LX220	10 1/2"	Silver	Medium	Angled jaw	1
	LX230	10 1/2"	Silver	Medium	Right angle	1

<b>LIGACLIP® Multi-Patient Single-Clip Applier - Green</b> 	PRODUCT CODE	LENGTH	HANDLE COLOR	CLIP SIZE	SPECIFICATION	EA / BX
	LC307	7 1/2"	Green	Medium / Large	-	1
	LC310	10 1/2"	Green	Medium / Large	-	1
	LC320	10 1/2"	Green	Medium / Large	Angled jaw	1



# Ligation

The Ethicon portfolio of endoscopic and open ligation devices are designed to provide optimal patient surgical experiences. Our deep understanding of the interaction between surgical tools and living tissue has enabled us to design solutions for confident occlusion.

<b>LIGACLIP® Multi-Patient Single-Clip Applier - Yellow</b> 	PRODUCT CODE	LENGTH	HANDLE COLOR	CLIP SIZE	SPECIFICATION	EA / BX
	LC407	7 1/2"	Yellow	Large	-	1
	LC410	10 1/2"	Yellow	Large	-	1
	LC420	10 1/2"	Yellow	Large	Angled jaw	1
	LC430	10 1/2"	Yellow	Large	Right angle	1

<b>LIGACLIP® Ligating Clip Cartridge Base</b> 	PRODUCT CODE	DESCRIPTION	EA / BX
	LC800	LIGACLIP® Ligating Clip Cartridge Base	1

<b>LIGACLIP® EXTRA Ligating Clips</b> - For use with open and endoscopic single clip appliers 	PRODUCT CODE	TYPE	HANDLE COLOR	CLIP SIZE	NUMBER OF CLIPS	EA / BX
	LT100	Open single	Blue	Small	6	36
	LT102	Open single	Blue	Small	20	15
	LT200	Open / endo	Silver	Medium	6	36
	LT202	Open / endo	Silver	Medium	20	15
	LT300	Open / endo	Green	Medium / Large	6	18
	LT400	Open / endo	Yellow	Large	6	18





# Surgical Stapling

Reliable tissue repair is a critical factor for all surgery. That's why Ethicon has worked with surgeons worldwide to develop and refine our surgical staplers and cutters. Our surgical stapling portfolio addresses the issues of tissue thickness, staple line security, and tissue tension to provide you solutions that are designed to enhance control and patient safety.

<b>ECHELON FLEX™ Powered Vascular Stapler with Advanced Placement Tip</b> 	PRODUCT CODE	DESCRIPTION	EA / BX
	PVE35A	35mm Standard Articulating Endoscopic Linear Cutter,* 320mm	3

<b>ENDOPATH ECHELON™ Vascular White Reload for Advanced Placement Tip - 35mm</b> 	PRODUCT CODE	CARTRIDGE COLOR	STAPLE ROWS	TISSUE THICKNESS	OPEN STAPLE HEIGHT	CLOSED STAPLE HEIGHT	EA / BX
	VASECR35	White	4	Vascular/thin	2.5mm	1.0mm	12

<b>ECHELON FLEX™ Powered ENDOPATH® 60mm Stapler</b> 	PRODUCT CODE	SHAFT LENGTH	ARTICULATION	MAXIMUM FIRINGS	EA / BX
	PCE60A	280mm	Yes	12	3
	PSE60A	340mm	Yes	12	3
	PLE60A	440mm	Yes	12	3

<b>ECHELON FLEX™ Powered ENDOPATH® 45mm Stapler</b> 	PRODUCT CODE	SHAFT LENGTH	ARTICULATION	MAXIMUM FIRINGS	EA / BX
	PCE45A	280mm	Yes	12	3
	PSE45A	340mm	Yes	12	3
	PLE45A	440mm	Yes	12	3





# Surgical Stapling

Reliable tissue repair is a critical factor for all surgery. That's why Ethicon has worked with surgeons worldwide to develop and refine our surgical staplers and cutters. Our surgical stapling portfolio addresses the issues of tissue thickness, staple line security, and tissue tension to provide you solutions that are designed to enhance control and patient safety.

<b>ECHELON FLEX™ ENDOPATH® 45mm Stapler</b> 	PRODUCT CODE	SHAFT LENGTH	ARTICULATION	MAXIMUM FIRINGS	EA / BX
	SC45A	280mm	Yes	12	3
	EC45A	340mm	Yes	12	3
	EC45AL	440mm	Yes	12	3

<b>ECHELON FLEX™ ENDOPATH® 60mm Stapler</b> 	PRODUCT CODE	SHAFT LENGTH	ARTICULATION	MAXIMUM FIRINGS	EA / BX
	SC60A	280mm	Yes	12	3
	EC60A	340mm	Yes	12	3
	LONG60A	440mm	Yes	12	3

<b>ECHELON ENDOPATH™ 45mm Staplers</b> 	PRODUCT CODE	SHAFT LENGTH	ARTICULATION	MAXIMUM FIRINGS	EA / BX
	SC45	280mm	No	12	3
	EC45	340mm	No	12	3
	ECLG45	440mm	No	12	3

<b>ECHELON ENDOPATH™ 60mm Staplers</b> 	PRODUCT CODE	SHAFT LENGTH	ARTICULATION	MAXIMUM FIRINGS	EA / BX
	SC60	280mm	No	12	3
	EC60	340mm	No	12	3
	LONG60	440mm	No	12	3



# Surgical Stapling

Reliable tissue repair is a critical factor for all surgery. That's why Ethicon has worked with surgeons worldwide to develop and refine our surgical staplers and cutters. Our surgical stapling portfolio addresses the issues of tissue thickness, staple line security, and tissue tension to provide you solutions that are designed to enhance control and patient safety.

ECHELON 45mm Reloads - For use with all ECHELON 45mm Endoscopic Staplers	PRODUCT CODE	CARTRIDGE COLOR	NUMBER OF STAPLES	TISSUE THICKNESS	OPEN STAPLE HEIGHT	CLOSED STAPLE HEIGHT	EA / BX
		ECR45M	Gray	6	Mesentery/thin	2.0mm	.75mm
	ECR45W	White	6	Vascular/thin	2.5mm	1.0mm	12
	ECR45B	Blue	6	Regular	3.5mm	1.5mm	12
	ECR45D	Gold	6	Regular/thick	3.8mm	1.8mm	12
	ECR45G	Green	6	Thick	4.1mm	2.0mm	12

ECHELON 60mm Reloads - For use with all ECHELON 60mm Endoscopic Staplers	PRODUCT CODE	CARTRIDGE COLOR	NUMBER OF STAPLES	TISSUE THICKNESS	OPEN STAPLE HEIGHT	CLOSED STAPLE HEIGHT	EA / BX
		ECR60M	Gray	6	Mesentery/thin	2.0mm	.75mm
	ECR60W	White	6	Vascular/thin	2.5mm	1.0mm	12
	ECR60B	Blue	6	Regular	3.5mm	1.5mm	12
	ECR60D	Gold	6	Regular/thick	3.8mm	1.8mm	12
	ECR60G	Green	6	Thick	4.1mm	2.0mm	12
	ECR60T	Black	6	Very thick	4.4mm	2.3mm	12

ENDOPATH® ETS 35mm Articulating Linear Cutter	PRODUCT CODE	SHAFT LENGTH	ARTICULATION	RELOAD INCLUDED	MAXIMUM FIRINGS	EA / BX
		ATB35	340mm	Yes	Yes	8
	ATW35	340mm	Yes	Yes	8	3

ENDOPATH® ETS 45mm Articulating Linear Cutter	PRODUCT CODE	SHAFT LENGTH	ARTICULATION	RELOAD INCLUDED	MAXIMUM FIRINGS	EA / BX
		CTS45	240mm	Yes	No	8
	ATS45	340mm	Yes	No	8	3
	ATS45NK	340mm	Yes	No	8	3
	LONG45A	440mm	Yes	No	8	3



# Surgical Stapling

Reliable tissue repair is a critical factor for all surgery. That's why Ethicon has worked with surgeons worldwide to develop and refine our surgical staplers and cutters. Our surgical stapling portfolio addresses the issues of tissue thickness, staple line security, and tissue tension to provide you solutions that are designed to enhance control and patient safety.

ENDOPATH® ETS 35mm Linear Cutters	PRODUCT CODE	SHAFT LENGTH	ARTICULATION	RELOAD INCLUDED	MAXIMUM FIRINGS	EA / BX
		TSB35	340mm	No	Yes	8
	TSW35	340mm	No	Yes	8	3

ENDOPATH® ETS 35mm Linear Cutters - For use with all ETS 35mm Endoscopic Cutters	PRODUCT CODE	CARTRIDGE COLOR	NUMBER OF STAPLES	TISSUE THICKNESS	OPEN STAPLE HEIGHT	CLOSED STAPLE HEIGHT	EA / BX
		TR35W	White	6	Vascular/thin	2.5mm	1.0mm
	TR35B	Blue	6	Regular	3.5mm	1.5mm	12

ENDOPATH® ETS 45mm Linear Cutters - For use with all ETS 45mm Endoscopic Cutters	PRODUCT CODE	CARTRIDGE COLOR	NUMBER OF STAPLES	TISSUE THICKNESS	OPEN STAPLE HEIGHT	CLOSED STAPLE HEIGHT	EA / BX
		6R45M	Gray	6	Mesentery/thin	2.0mm	.85mm
	TR45W	White	6	Vascular/thin	2.5mm	1.0mm	12
	6R45B	Blue	6	Regular	3.5mm	1.5mm	12
	TR45G	Green	4	Thick	4.1mm	2.0mm	12



# Surgical Stapling

Reliable tissue repair is a critical factor for all surgery. That's why Ethicon has worked with surgeons worldwide to develop and refine our surgical staplers and cutters. Our surgical stapling portfolio addresses the issues of tissue thickness, staple line security, and tissue tension to provide you solutions that are designed to enhance control and patient safety.

<b>PROXIMATE® Curved Intraluminal Stapler</b> 	PRODUCT CODE	SHAFT LENGTH	ADJUSTABLE CLOSED STAPLE HEIGHT	HEAD DIAMETER	LUMEN	OPEN LEG LENGTH	EA / BX
	CDH21A	18cm	1.0 - 2.5mm	21mm	12.4mm	5.5mm	3
CDH25A	18cm	1.0 - 2.5mm	25mm	16.4mm	5.5mm	3	
CDH29A	18cm	1.0 - 2.5mm	29mm	20.4mm	5.5mm	3	
CDH33A	18cm	1.0 - 2.5mm	33mm	24.4mm	5.5mm	3	

<b>ENDOPATH® Endoscopic Curved Intraluminal Circular Stapler</b> 	PRODUCT CODE	SHAFT LENGTH	ADJUSTABLE CLOSED STAPLE HEIGHT	HEAD DIAMETER	LUMEN	OPEN LEG LENGTH	EA / BX
	ECS21A	28cm	1.0 - 2.5mm	21mm	12.4mm	5.5mm	3
ECS25A	28cm	1.0 - 2.5mm	25mm	16.4mm	5.5mm	3	
ECS29A	28cm	1.0 - 2.5mm	29mm	20.4mm	5.5mm	3	
ECS33A	28cm	1.0 - 2.5mm	33mm	24.4mm	5.5mm	3	



# Surgical Stapling

Reliable tissue repair is a critical factor for all surgery. That's why Ethicon has worked with surgeons worldwide to develop and refine our surgical staplers and cutters. Our surgical stapling portfolio addresses the issues of tissue thickness, staple line security, and tissue tension to provide you solutions that are designed to enhance control and patient safety.

<b>PROXIMATE® Straight Intraluminal Stapler</b> 	PRODUCT CODE	SHAFT LENGTH	ADJUSTABLE CLOSED STAPLE HEIGHT	HEAD DIAMETER	LUMEN	OPEN LEG LENGTH	EA / BX
	SDH21A	18cm	1.0 - 2.5mm	21mm	12.4mm	5.5mm	3
	SDH25A	18cm	1.0 - 2.5mm	25mm	16.4mm	5.5mm	3
	SDH29A	18cm	1.0 - 2.5mm	29mm	20.4mm	5.5mm	3
	SDH33A	18cm	1.0 - 2.5mm	33mm	24.4mm	5.5mm	3

<b>PROXIMATE® ILS Circular Sizer Set</b> 	PRODUCT CODE	DESCRIPTION	EA / BX
	CSS	Bowel sizers for the ENDOPATH® ILS Curved Staplers, the set includes one each of a 25mm, 29mm, and 33mm sizer	1

<b>CONTOUR® Curved Cutter Stapler</b> 		PRODUCT CODE	CARTRIDGE COLOR	NUMBER OF STAPLE ROWS	TISSUE THICKNESS	OPEN STAPLE HEIGHT	CLOSED STAPLE HEIGHT	RELOAD INCLUDED	MAXIMUM FIRINGS	EA / BX
		CS40B	Blue	4	Regular	3.5mm	1.44mm	Yes	6	3
		CS40G	Green	4	Thick	4.7mm	2.0mm	Yes	6	3

<b>CONTOUR® Curved Cutter Stapler Cartridge</b> 	RELOAD CODE	CARTRIDGE COLOR	NUMBER OF STAPLES ROWS	TISSUE THICKNESS	OPEN STAPLE HEIGHT	CLOSED STAPLE HEIGHT	EA / BX
	CR40B	Blue	4	Regular	3.5mm	1.44mm	3
	CR40G	Green	4	Thick	4.7mm	2.0mm	3



# Surgical Stapling

Reliable tissue repair is a critical factor for all surgery. That's why Ethicon has worked with surgeons worldwide to develop and refine our surgical staplers and cutters. Our surgical stapling portfolio addresses the issues of tissue thickness, staple line security, and tissue tension to provide you solutions that are designed to enhance control and patient safety.



ETHICON ENDO-SURGERY™ Linear Cutter	PRODUCT CODE	SHAFT LENGTH	NUMBER OF STAPLED ROWS	SELECTABLE CLOSED STAPLE HEIGHT	MAXIMUM FIRINGS	EA / BX
	N TLC55	55mm	6	1.5mm, 1.8mm, 2.0mm	12	3
	N TLC75	75mm	6	1.5mm, 1.8mm, 2.0mm	12	3

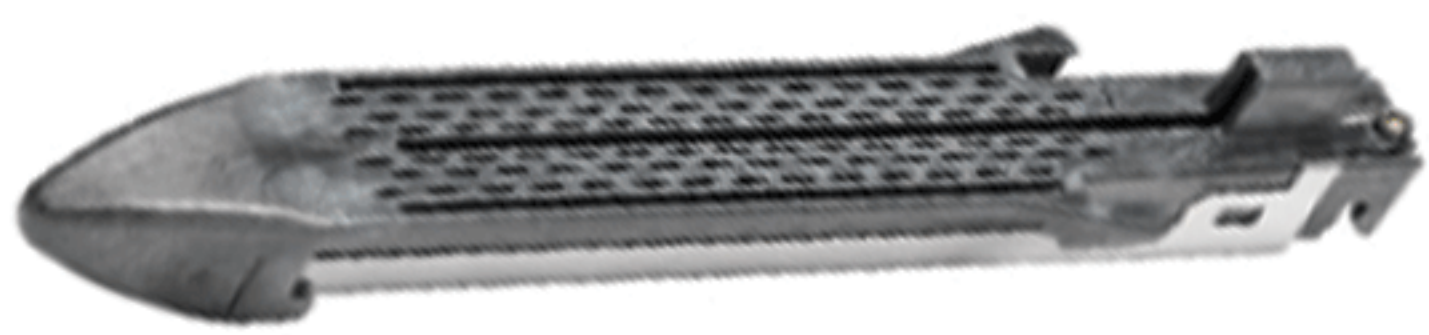

ETHICON ENDO-SURGERY™ Linear Cutter Cartridge	RELOAD CODE	NUMBER OF STAPLED ROWS	SELECTABLE CLOSED STAPLE HEIGHT	EA / BX
	SR55	6	1.5mm, 1.8mm, 2.0mm	12
	SR75	6	1.5mm, 1.8mm, 2.0mm	12







PROXIMATE® Linear Cutter								
PRODUCT CODE	CARTRIDGE COLOR	NUMBER OF STAPLE ROWS	TISSUE THICKNESS	OPEN STAPLE HEIGHT	CLOSED STAPLE HEIGHT	RELOAD INCLUDED	MAXIMUM FIRINGS	EA / BX
TVC55	White	4	Vascular/thin	2.50mm	1.0mm	Yes	8	3
TLC55	Blue	4	Regular	3.85mm	1.5mm	Yes	8	3
TCT55	Green	4	Thick	4.50mm	2.0mm	Yes	8	3
TLC75	Blue	4	Regular	3.85mm	1.5mm	Yes	8	3
TCD75	Gold	4	Regular/thick	4.20mm	1.8mm	Yes	8	3
TCT75	Green	4	Thick	4.50mm	2.0mm	Yes	8	3
TLC10	Blue	4	Regular	3.85mm	1.5mm	Yes	8	3
TCT10	Green	4	Thick	4.50mm	2.0mm	Yes	8	3

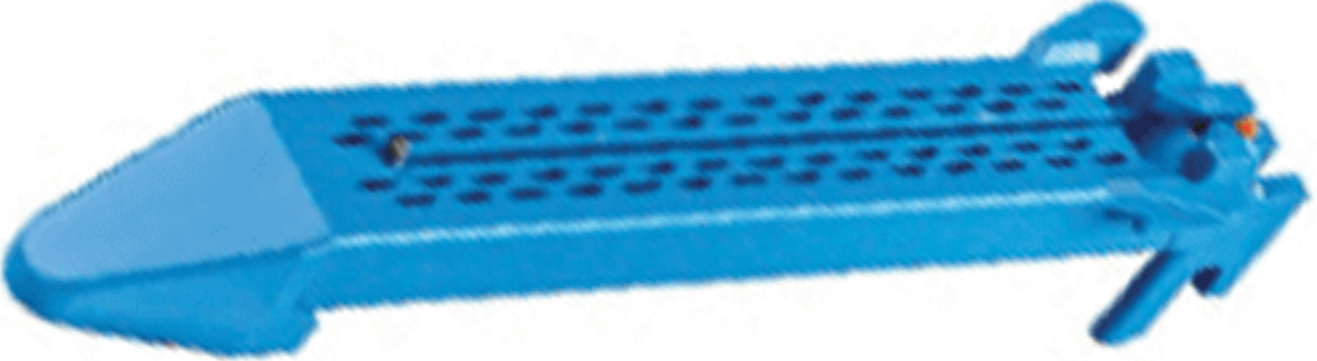

# Surgical Stapling

Reliable tissue repair is a critical factor for all surgery. That's why Ethicon has worked with surgeons worldwide to develop and refine our surgical staplers and cutters. Our surgical stapling portfolio addresses the issues of tissue thickness, staple line security, and tissue tension to provide you solutions that are designed to enhance control and patient safety.

<b>PROXIMATE® Linear Cutter Cartridge</b>		RELOAD CODE	CARTRIDGE COLOR	NUMBER OF STAPLES ROWS	TISSUE THICKNESS	OPEN STAPLE HEIGHT	CLOSED STAPLE HEIGHT	EA / BX
TVR55		TVR55	White	4	Vascular/thin	4.20mm	1.8mm	12
TCR55		TCR55	Blue	4	Regular	3.85mm	1.5mm	12
TCR75		TRT55	Green	4	Thick	4.50mm	2.0mm	12
TRD75		TCR75	Blue	4	Regular	3.85mm	1.5mm	12
TRT75		TRD75	Gold	4	Regular/thick	4.20mm	1.8mm	12
		TRT75	Green	4	Thick	4.50mm	2.0mm	12
		TCR10	Blue	4	Regular/thick	3.85mm	1.5mm	12
		TRT10	Green	4	Thick	4.50mm	2.0mm	12

<b>PROXIMATE® Reloadable Staplers (TL/TLH/TLV)</b>		PRODUCT CODE	TISSUE THICKNESS	MAXIMUM CLOSED STAPLE HEIGHT	RELOAD INCLUDED	MAXIMUM FIRINGS	EA / BX
TL30		TL30	1.0 - 2.5mm	1.0mm	Yes	4	3
TL60		TL60	1.0 - 2.5mm	1.0mm	Yes	4	3
TL90		TL90	1.0 - 2.5mm	1.0mm	Yes	4	3
		TLH30	1.0 - 2.5mm	1.0mm	Yes	4	3
		TLH60	1.5 - 2.5mm	1.5mm	Yes	4	3
		TLH90	1.5 - 2.5mm	1.5mm	Yes	4	3
		TLV30	1.0mm	1.0mm	Yes	4	3



# Surgical Stapling

Reliable tissue repair is a critical factor for all surgery. That's why Ethicon has worked with surgeons worldwide to develop and refine our surgical staplers and cutters. Our surgical stapling portfolio addresses the issues of tissue thickness, staple line security, and tissue tension to provide you solutions that are designed to enhance control and patient safety.

TL Linear Stapler with Dial		PRODUCT CODE	EA / BX
TR30		TR30	12
TR60		TR60	12
TR90		TR90	12

TLH Linear Stapler with Dial		PRODUCT CODE	EA / BX
TRV30		TRV30	12
TRH30		TRH30	12
TRH60		TRH60	12
TRH90		TRH90	12

PROXIMATE® Reloadable Staplers (TX)								
								
PRODUCT CODE	CARTRIDGE COLOR	NUMBER OF STAPLE ROWS	TISSUE THICKNESS	OPEN STAPLE HEIGHT	CLOSED STAPLE HEIGHT	RELOAD INCLUDED	MAXIMUM FIRINGS	EA / BX
TX30V	White	3	Vascular	2.5mm	1.0mm	Yes	8	3
TX30B	Blue	2	Regular	3.5mm	1.5mm	Yes	8	3
TX30G	Green	2	Thick	4.8mm	2.0mm	Yes	8	3
TX60B	Blue	2	Regular	3.5mm	1.5mm	Yes	8	3
TX60G	Green	2	Thick	4.8mm	2.0mm	Yes	8	3



# Surgical Stapling

Reliable tissue repair is a critical factor for all surgery. That's why Ethicon has worked with surgeons worldwide to develop and refine our surgical staplers and cutters. Our surgical stapling portfolio addresses the issues of tissue thickness, staple line security, and tissue tension to provide you solutions that are designed to enhance control and patient safety.

<b>PROXIMATE® Reloadable Staplers Cartridge (TX)</b> 	PRODUCT CODE	CARTRIDGE COLOR	NUMBER OF STAPLES	TISSUE THICKNESS	OPEN STAPLE HEIGHT	CLOSED STAPLE HEIGHT	EA / BX
	XR30V	White	3	Vascular	2.0mm	1.0mm	12
XR30B	Blue	2	Regular	3.5mm	1.5mm	12	
XR30G	Green	2	Thick	4.8mm	2.0mm	12	
XR60B	Blue	2	Regular	3.5mm	1.5mm	12	
XR60G	Green	2	Thick	4.8mm	2.0mm	12	

<b>PROXIMATE® Hemorrhoidal Circular Stapler</b> 	PRODUCT CODE	NUMBER OF STAPLE ROWS	CLOSED STAPLE HEIGHT	KNIFE DIAMETER	NUMBER OF STAPLES	STAPLE LEG LENGTH	EA / BX
	PPH03	2	0.75mm- 1.5mm	24.4mm	28	4mm	3





# Uterine & Pelvic Surgery

Ethicon has worked with gynecologists to create innovative new solutions for a greater choice of procedure. Plus, we've aligned our portfolio to the surgical treatment pathway so you can ensure you have the right solutions for the right procedure. Enhanced technique combined with innovative technologies helps to improve surgical performance.

GYNECARE INTERCEED® Absorbable Adhesion Barrier	PRODUCT CODE	DESCRIPTION	EA / BX
		4350	GYNECARE INTERCEED® Absorbable Adhesion Barrier, 3" x 4" (7.6cm x 10.2cm)
	4350XL	GYNECARE INTERCEED® Absorbable Adhesion Barrier XL, 5" x 6" (12.7cm x 15.2cm)	10

\* Essential product information regarding the GYNECARE INTERCEED® Absorbable Adhesion Barrier can be found at the end of the product catalog.

GYNECARE TVT ABBREVO® Continenence System	PRODUCT CODE	DESCRIPTION	EA / BX
		TVTOML	GYNECARE TVT ABBREVO®

GYNECARE TVT EXACT® Continenence System	PRODUCT CODE	DESCRIPTION	EA / BX
		TVTRL	GYNECARE TVT EXACT®

GYNECARE TVT™ Obturator System - tension-free support for incontinence	PRODUCT CODE	DESCRIPTION	EA / BX	
		810081	GYNECARE TVT™ Obturator System	1
		810081L	GYNECARE TVT™ Laser Cut Obturator System	1

GYNECARE TVT™ Retropubic System - tension-free support for incontinence	PRODUCT CODE	DESCRIPTION	EA / BX	
		810041A	GYNECARE TVT™ with abdominal guides	1
		810041B	GYNECARE TVT™ (mechanical cut mesh)	1
		810041BL	GYNECARE TVT™ (laser cut mesh)	1
		810051	Introducer handle (reusable)	1
		810061	Rigid catheter guide (reusable)	1



# Uterine & Pelvic Surgery

Ethicon has worked with gynecologists to create innovative new solutions for a greater choice of procedure. Plus, we've aligned our portfolio to the surgical treatment pathway so you can ensure you have the right solutions for the right procedure. Enhanced technique combined with innovative technologies helps to improve surgical performance.

<b>GYNECARE THERMACHOICE® III Uterine Balloon Therapy System</b> 	PRODUCT CODE	DESCRIPTION	EA / BX
		00825	Controller (comes with power cord)
	01105	Umbilical cable	1
	04995	Power cord (U.S. and Canada)	1
	TC003	Catheter (5 pack)	5
	TC013	Catheter (1 pack)	1
	XW200595	Controller 2-year extended service contract	1

\* Essential product information regarding the GYNECARE THERMACHOICE® III Uterine Balloon Therapy System can be found at the end of the product catalog.

<b>GYNECARE VERSAPOINT™ Bipolar Electrosurgery System</b> 	PRODUCT CODE	DESCRIPTION	EA / BX
		00482	Bipolar generator
	00481	Foot switch	1
	00480	Connector cable (handpiece)	1
	04995	Universal Power Cord (U.S. and Canada)	1
	01936	Hysteroscope 4.0mm 30 degree wide angle lens	1
	01938	Hysteroscope 4.0mm 12 degree high magnification lens	1
	01735	Resectoscope hysteroscopic bridge/visual obturator	1
	01939	Resectoscope rotating outer sheath 27Fr	1
	01934	Resectoscope obturator - standard	1
	01931	Resectoscope working element - passive	1
	00466	Ball tip electrode - 5pk	5
	00467	Twizzle tip electrode - 5pk	5
	004628	Spring tip electrode - 5pk	5
	01950	Bipolar electrode, resectoscopic - vaporizing tip (0 degree) - 5pk	5
	01985	Bipolar electrode, resectoscopic - angled loop tip - 5pk	5
	XW200482	Generator 2-year extended service contract	1



# Uterine & Pelvic Surgery

Ethicon has worked with gynecologists to create innovative new solutions for a greater choice of procedure. Plus, we've aligned our portfolio to the surgical treatment pathway so you can ensure you have the right solutions for the right procedure. Enhanced technique combined with innovative technologies helps to improve surgical performance.

<b>ARTISYN® Y-Shaped Mesh</b> 	PRODUCT CODE	SIZE	EA / BX
	ARTY	27cm x 5cm	1
	ARTY5L	27cm x 5cm	5

<b>GYNECARE GYNEMESH® PS</b> <b>Nonabsorbable PROLENE® Soft Mesh</b> 	PRODUCT CODE	SIZE	EA / BX
	GPSL	10cm x 15cm	1
	GPSXL3	25cm x 25cm	3



# Wound Closure

Secure skin closure is an integral part of nearly every surgical procedure. Ethicon has pioneered advances in skin closure that enable you to minimize tissue trauma, optimize healing, and improve patient outcomes. We offer a portfolio of innovative wound closure solutions designed for the specific needs of skin, fascia, and organ tissues.

## STRATAFIX™ Spiral PDO Knotless Tissue Control Device

- bidirectional dyed























PRODUCT CODE	IMAGE	NEEDLE	SIZE	LENGTH	EA / BX
SXPD2B421		19mm, 3/8 circle reverse cutting, FS-2	5-0	7cm x 7cm	1
SXPD2B422		19mm, 3/8 circle reverse cutting, FS-2	4-0	7cm x 7cm	1
SXPD2B423		19mm, 3/8 circle reverse cutting, FS-2	4-0	14cm x 14cm	1
SXPD2B417		26mm, 3/8 circle reverse cutting, FS	3-0	14cm x 14cm	1
SXPD2B418		26mm, 3/8 circle reverse cutting, FS	2-0	14cm x 14cm	1
SXPD2B419		26mm, 3/8 circle reverse cutting, FS	3-0	14cm x 14cm	1
SXPD2B420		26mm, 3/8 circle reverse cutting, FS	2-0	14cm x 14cm	1
SXPD2B415		26mm, 1/2 circle reverse cutting, CP-2	0	24cm x 24cm	1
SXPD2B416		26mm, 1/2 circle reverse cutting, CP-2	1	24cm x 24cm	1
SXPD2B200		36mm, 1/2 circle reverse cutting, OS-6	1	24cm x 24cm	1
SXPD2B201		36mm, 1/2 circle reverse cutting, OS-6	1	30cm x 30cm	1
SXPD2B202		40mm, 1/2 circle reverse cutting, OS-8	1	36cm x 36cm	1
SXPD2B426		17mm, 3/8 circle tapercut, V-4	4-0	24cm x 24cm	1
SXPD2B425		26mm, 3/8 circle tapercut, V-26	4-0	14cm x 14cm	1
SXPD2B424		26mm, 3/8 circle tapercut, V-26	4-0	24cm x 24cm	1
SXPD2B404		22mm, 1/2 circle taper point, CT-3	0	14cm x 14cm	1
SXPD2B413		22mm, 1/2 circle taper point, SH	2-0	10cm x 10cm	1
SXPD2B414		22mm, 1/2 circle taper point, SH	2-0	14cm x 14cm	1
SXPD2B406		36mm, 1/2 circle taper point, MH	2-0	7cm x 7cm	1
SXPD2B407		36mm, 1/2 circle taper point, MH	2-0	14cm x 14cm	1
SXPD2B409		36mm, 1/2 circle taper point, MH	0	14cm x 14cm	1
SXPD2B408		36mm, 1/2 circle taper point, MH	2-0	24cm x 24cm	1
SXPD2B410		36mm, 1/2 circle taper point, MH	0	24cm x 24cm	1
SXPD2B411		36mm, 1/2 circle taper point, MH	0	30cm x 30cm	1
SXPD2B412		36mm, 1/2 circle taper point, MH	2-0	36cm x 36cm	1
SXPD2B401		36mm, 1/2 circle taper point, CT-1	0	14cm x 14cm	1
SXPD2B402		36mm, 1/2 circle taper point, CT-1	0	24cm x 24cm	1
SXPD2B403		36mm, 1/2 circle taper point, CT-1	0	30cm x 30cm	1
SXPD2B400		36mm, 1/2 circle taper point, MO-4	0	36cm x 36cm	1
SXPD2B405		48mm, 1/2 circle taper point, CTX	0	36cm x 36cm	1



# Wound Closure























Secure skin closure is an integral part of nearly every surgical procedure. Ethicon has pioneered advances in skin closure that enable you to minimize tissue trauma, optimize healing, and improve patient outcomes. We offer a portfolio of innovative wound closure solutions designed for the specific needs of skin, fascia, and organ tissues.

<b>STRATAFIX™ Spiral PGA-PCL Knotless Tissue Control Device</b> - bidirectional undyed		PRODUCT CODE	IMAGE	NEEDLE	SIZE	LENGTH	EA / BX
	SXMD2B405		19mm, 3/8 circle reverse cutting, FS-2	4-0	7cm x 7cm	1	
	SXMD2B404		19mm, 3/8 circle reverse cutting, FS-2	3-0	7cm x 7cm	1	
	SXMD2B407		19mm, 3/8 circle reverse cutting, FS-2	4-0	14cm x 14cm	1	
	SXMD2B406		19mm, 3/8 circle reverse cutting, FS-2	3-0	14cm x 14cm	1	
	SXMD2B409		19mm, 3/8 circle reverse cutting, FS-2	4-0	30cm x 30cm	1	
	SXMD2B408		19mm, 3/8 circle reverse cutting, FS-2	3-0	30cm x 30cm	1	
	SXMD2B150**		24mm, 3/8 circle reverse cutting, FS-1	4-0	30cm x 30cm	1	
	SXMD2B410		24mm, 3/8 circle reverse cutting, FS-1	3-0	30cm x 30cm	1	
	SXMD2B411		26mm, 3/8 circle reverse cutting, FS	3-0	14cm x 14cm	1	
	SXMD2B413		26mm, 3/8 circle reverse cutting, FS	4-0	30cm x 30cm	1	
	SXMD2B412		26mm, 3/8 circle reverse cutting, FS	3-0	30cm x 30cm	1	
	SXMD2B414		26mm, 1/2 circle reverse cutting, CP-2	2-0	14cm x 14cm	1	
	SXMD2B403		17mm, 1/2 circle taper point, RB-1	4-0	16cm x 16cm	1	
	SXMD2B402		17mm, 1/2 circle taper point, RB-1	3-0	16cm x 16cm	1	
	SXMD2B400		36mm, 1/2 circle taper point, MH	2-0	14cm x 14cm	1	
	SXMD2B401		36mm, 1/2 circle taper point, MH	2-0	36cm x 36cm	1	
<b>STRATAFIX™ Spiral Polypropylene Knotless Tissue Control Device</b> - bidirectional undyed		PRODUCT CODE	IMAGE	NEEDLE	SIZE	LENGTH	EA / BX
	SXPL2B401		22mm, 1/2 circle taper point, CT-3	0	14cm x 14cm	1	
	SXPL2B400		36mm, 1/2 circle taper point, CT-1	1	24cm x 24cm	1	



# Wound Closure

Secure skin closure is an integral part of nearly every surgical procedure. Ethicon has pioneered advances in skin closure that enable you to minimize tissue trauma, optimize healing, and improve patient outcomes. We offer a portfolio of innovative wound closure solutions designed for the specific needs of skin, fascia, and organ tissues.

STRATAFIX™ Spiral PGA-PCL Knotless Tissue Control Device - unidirectional undyed		PRODUCT CODE	IMAGE	NEEDLE	SIZE	LENGTH	EA / BX
		SXMD1B105		19mm, 3/8 circle reverse cutting, PS-2	4-0	30cm	1
		SXMD1B103		19mm, 3/8 circle reverse cutting, PS-2	3-0	30cm	1
		SXMD1B106		19mm, 3/8 circle reverse cutting, PS-2	4-0	60cm	1
		SXMD1B104		19mm, 3/8 circle reverse cutting, PS-2	3-0	60cm	1
		SXMD1B100		24mm, 3/8 circle reverse cutting, PS-1	3-0	30cm	1
		SXMD1B101		24mm, 3/8 circle reverse cutting, PS-1	3-0	60cm	1
		SXMD1B102		30mm, 3/8 circle reverse cutting, PSL	2-0	60cm	1
		SXMD1B402		17mm, 1/2 circle taper point, RB-1	4-0	20cm	1
		SXMD1B403		17mm, 1/2 circle taper point, RB-1	3-0	20cm	1
		SXMD1B404		17mm, 1/2 circle taper point, RB-1	2-0	20cm	1
		SXMD1B405		26mm, 1/2 circle taper point, SH	3-0	20cm	1
		SXMD1B406		26mm, 1/2 circle taper point, SH	2-0	20cm	1
		SXMD1B407		36mm, 1/2 circle taper point, CT-1	3-0	45cm	1
		SXMD1B408		36mm, 1/2 circle taper point, CT-1	2-0	45cm	1
		SXMD1B409		36mm, 1/2 circle taper point, CT-1	0	45cm	1
STRATAFIX™ Spiral PDO Knotless Tissue Control Device - unidirectional dyed		PRODUCT CODE	IMAGE	NEEDLE	SIZE	LENGTH	EA / BX
		SXPD1B101		19mm, 3/8 circle reverse cutting, PS-2	4-0	45cm	1
		SXPD1B100		19mm, 3/8 circle reverse cutting, PS-2	3-0	45cm	1
		SXPD1B400		36mm, 1/2 taper point, CT-1	2-0	20cm	1
		SXPD1B401		36mm, 1/2 taper point, CT-1	2-0	30cm	1
STRATAFIX™ Spiral Polypropylene Knotless Tissue Control Device - unidirectional undyed		PRODUCT CODE		NEEDLE	SIZE	LENGTH	EA / BX
		SXPL1B400		22mm, 1/2 taper point, SH-1	2-0	30cm	1



# Wound Closure

Secure skin closure is an integral part of nearly every surgical procedure. Ethicon has pioneered advances in skin closure that enable you to minimize tissue trauma, optimize healing, and improve patient outcomes. We offer a portfolio of innovative wound closure solutions designed for the specific needs of skin, fascia, and organ tissues.

DERMABOND ADVANCED® Topical Skin Adhesive	PRODUCT CODE	DESCRIPTION	ADHESIVE VOLUME	EA / BX
		DNX12	Unique formulation with an easy-to-use applicator for precise control for wide and fine line applications	0.7mL
DNX6		Unique formulation with an easy-to-use applicator for precise control for wide and fine line applications	0.7mL	6

DERMABOND PRINEO® Skin Closure System	PRODUCT CODE	DESCRIPTION	ADHESIVE VOLUME	EA / BX
		CLR222US	2-octylcyanoacrylate topical skin adhesive applicator. Flexible, self-adhesive polyester mesh tape dispenser	22cm
CLR602US		2-octylcyanoacrylate topical skin adhesive applicator. Flexible, self-adhesive polyester mesh tape dispenser	60cm	2





DERMABOND® Mini Topical Skin Adhesive	PRODUCT CODE	DESCRIPTION	ADHESIVE VOLUME	EA / BX
		DHVM12	2-octylcyanoacrylate high viscosity formulation for small incisions and lacerations	0.36mL

ENDOSUTURE ENDO-HOLDER™	PRODUCT CODE	DESCRIPTION	EA / BX
	EC11	EN-3 Needle - 0, 42" Suture	12
	EC12	EN-3 Needle - 2-0, 42" Suture	12
	ESS15	ENDO-HOLDER™ Cannula (for use with 5mm diameter trocar)	1

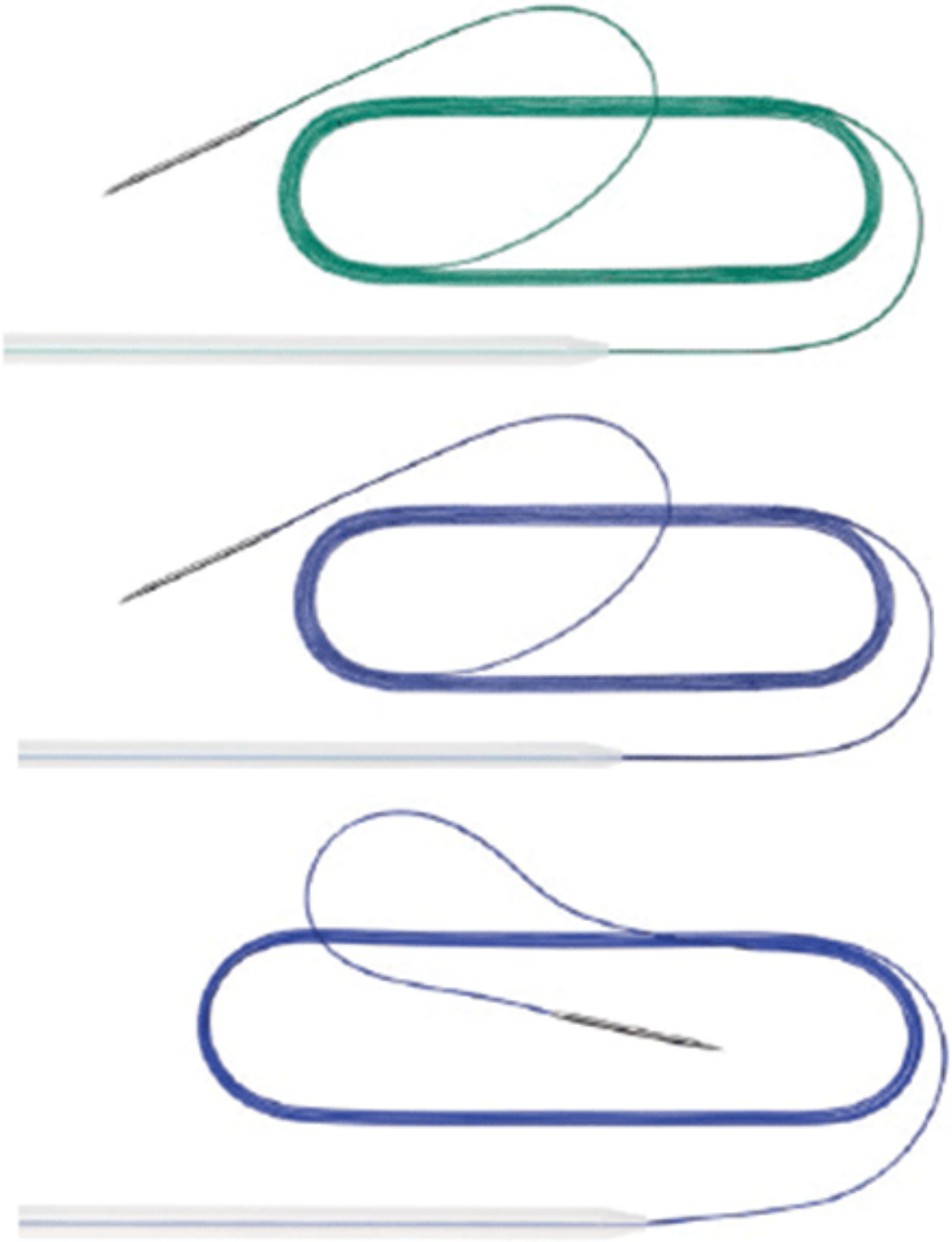

# Wound Closure





Secure skin closure is an integral part of nearly every surgical procedure. Ethicon has pioneered advances in skin closure that enable you to minimize tissue trauma, optimize healing, and improve patient outcomes. We offer a portfolio of innovative wound closure solutions designed for the specific needs of skin, fascia, and organ tissues.

<b>ENDOKNOT® Pre-Tied Suture</b>  	PRODUCT CODE	DESCRIPTION	EA / BX
	EX10G	ETHIBOND® Extra Suture, ST-3 needle, 0, 42"	12
	JK10G	Coated VICRYL® Suture, ST-3 needle, 0, 42"	12
	ZK10G	PDS® II Suture, ST-3 needle, 0, 42"	12
<b>ENDOLOOP® Ligature - made from PDS (polydioxanone) suture</b>  	PRODUCT CODE	DESCRIPTION	EA / BX
	EZ10G	ENDOLOOP® Ligature made from PDS® II 0 18" 12 (polydioxanone) Suture	12
<b>ENDOLOOP® Chromic (or plain) Gut Ligature VICRYL® (polyglactin 910) Suture</b>  	PRODUCT CODE	DESCRIPTION	EA / BX
	EJ10G	ENDOLOOP® Ligature made from VICRYL® 0 18" 12 (polyglactin 910) Suture	12
<b>ENDOPATH® Needle Holders</b>  	PRODUCT CODE	DESCRIPTION	EA / BX
	E705R	ENDOPATH® Needle Holder, reusable, 5mm, 30cm length	1
	E705RL	ENDOPATH® Needle Holder, reusable, 5mm, 45cm length	1
	SRNH1	Self Righting Needle Holder, reusable, 5mm, 30cm length	1
	SRNH1L	Self Righting Needle Holder, reusable, 5mm, 45cm length	1
<b>LAPRA-TY® Suture Clip</b>  	PRODUCT CODE	DESCRIPTION	EA / BX
	KA200	Sterile, one-piece clips molded from the polymer poly(p-dioxanone).	1
	KA200L	Sterile, one-piece clips molded from the polymer poly(p-dioxanone).	1
	XC200	Sterile, one-piece clips molded from the polymer poly(p-dioxanone).	6

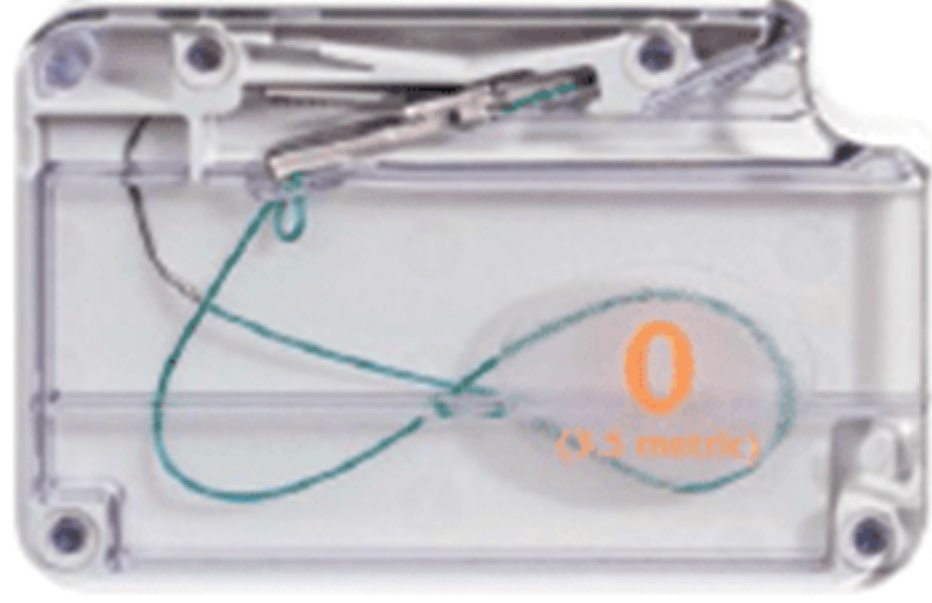

# Wound Closure

Secure skin closure is an integral part of nearly every surgical procedure. Ethicon has pioneered advances in skin closure that enable you to minimize tissue trauma, optimize healing, and improve patient outcomes. We offer a portfolio of innovative wound closure solutions designed for the specific needs of skin, fascia, and organ tissues.

Suture Assistant		PRODUCT CODE	NEEDLE TYPE	EA / BX
		SW100	N / A	4
		SW110	6" ETHIBOND EXCEL® (size O) and EEN (canoe) needle	10
		SW112	6" ETHIBOND EXCEL® (size 2-O) and EEN (canoe) needle	10
		SW120	6" ETHIBOND EXCEL® (size O) and SH needle	10
		SW122	6" ETHIBOND EXCEL® (size 2-O) and SH Needle	10
		SW222	6" VICRYL® (size 2-O) and SH Needle	10

PROXIMATE® Rotating Head Skin Staplers		PRODUCT CODE	NUMBER OF STAPLES	STAPLE LEG LENGTH	STAPLE WIRE DIAMETER	STAPLE CROWN	SIZE	EA / BX
		PRR35	35	3.9	0.53	5.7	Regular	6
		PRW35	35	3.9	0.58	6.9	White	6



# Wound Closure

Secure skin closure is an integral part of nearly every surgical procedure. Ethicon has pioneered advances in skin closure that enable you to minimize tissue trauma, optimize healing, and improve patient outcomes. We offer a portfolio of innovative wound closure solutions designed for the specific needs of skin, fascia, and organ tissues.

<b>PROXIMATE® Plus MD Skin Stapler</b> 	PRODUCT CODE	NUMBER OF STAPLES	STAPLE LEG LENGTH	STAPLE WIRE DIAMETER	STAPLE CROWN	SIZE	EA / BX
	PMR35	35	3.9	0.53	5.7	Regular	6
	PMW35	35	3.9	0.58	6.9	Wide	6

<b>PROXIMATE® PX Fixed Head Skin Staplers</b> 	PRODUCT CODE	NUMBER OF STAPLES	STAPLE LEG LENGTH	STAPLE WIRE DIAMETER	STAPLE CROWN	SIZE	EA / BX
	PXR35	35	3.9	0.53	5.7	Regular	6
	PXW35	35	3.9	0.58	6.9	Wide	6

<b>Staple Extractor</b> 	PRODUCT CODE	DESCRIPTION	EA / BX
	PSX	Squeeze handle staple extractor	12



# Other Devices

Whatever your needs during the course of surgery, Ethicon is committed to providing you a solution. From laparoscopic hand instruments to gastric banding, drains, and reservoirs, you can count us to provide you with outstanding value, excellent service, and a broad range of product offerings.

<b>ENDOPATH® Bipolar Forceps</b> 	PRODUCT CODE	SHAFT DIAMETER	JAW	EA / BX
	EBF01	5mm	Macro	5
	EBF02	5mm	Micro	5

<b>ENDOPATH® Active Cords - for use with bipolar forceps</b>			
PRODUCT CODE	DESCRIPTION		EA / BX
EBC02	Reusable coaxial pin connector bipolar cord, gray, 1 prong		1
EBC05	Active return cord for bipolar instruments fixed pin connector		1

<b>ENDOPATH® Scissors</b> 	PRODUCT CODE	DESCRIPTION	EA / BX
	5DCS	Scissors, curved, with monopolar cautery, 5mm	6

<b>ENDOPATH® Graspers</b> 	PRODUCT CODE	DESCRIPTION	EA / BX
	10AG	Anvil grasper	6
	5DSG	Grasper, 5mm	6





# Other Devices

Whatever your needs during the course of surgery, Ethicon is committed to providing you a solution. From laparoscopic hand instruments to gastric banding, drains, and reservoirs, you can count us to provide you with outstanding value, excellent service, and a broad range of product offerings.

<b>ENDOPATH® Graspers</b> 	PRODUCT CODE	DESCRIPTION	EA / BX
	5DCD	Dissector, curved, with monopolar cautery, 5mm	6
	BCD10	Dissector, blunt tip, 10mm, 3 per pouch, 12 pouches per sales unit	36
	BTD05	Dissector, blunt tip, 5mm, 3 per pouch, 12 pouches per sales unit	36

<b>ENDOPATH® Babcocks</b> 	PRODUCT CODE	DESCRIPTION	EA / BX
	5BB	Babcock, 5mm	6
	10BB	Babcock, 10mm	6

<b>Purse String Clamp - Multi-patient use</b> 	PRODUCT CODE	DESCRIPTION	EA / BX
	EH40	Reusable, purse string clamp	1

<b>ENDOPOUCH® Specimen Retrieval Bag</b> 	PRODUCT CODE	EA / BX
	POUCH	6



# Other Devices

Whatever your needs during the course of surgery, Ethicon is committed to providing you a solution. From laparoscopic hand instruments to gastric banding, drains, and reservoirs, you can count us to provide you with outstanding value, excellent service, and a broad range of product offerings.

<b>ENDOPATH® Electrosurgery PROBE PLUS® II System</b> 	PRODUCT CODE	GRIP	CONTROL	EA / BX
	EPH03	Pencil	Foot	6
	EPH04	Pencil	Hand	6

<b>ENDOPATH® Electrosurgery PROBE PLUS® II Electrode Shafts</b> 	PRODUCT CODE	SHAFT DIAMETER	SHAFT LENGTH	ELECTRODE	EA / BX
	EPS01	5mm	34cm	Hook	6
	EPS02	5mm	34cm	Spatula	6
	EPS03	5mm	34cm	Right angle	6
	EPS04	5mm	34cm	Curved dissector	6
	EPS05	5mm	29cm	Hook	6
	EPS06	5mm	29cm	Spatula	6
	EPS07	5mm	29cm	Right angle	6



# Other Devices

Whatever your needs during the course of surgery, Ethicon is committed to providing you a solution. From laparoscopic hand instruments to gastric banding, drains, and reservoirs, you can count us to provide you with outstanding value, excellent service, and a broad range of product offerings.

ENDOPATH® Electrosurgery PROBE PLUS® II Tubing	PRODUCT CODE	DESCRIPTION	EA / BX
		EPT01	PROBE PLUS® II, dual-bottle irrigation tube set
	EPT03	PROBE PLUS® II, pressurized bag irrigation tube set with spike	6





ETHICON ENDO-SURGERY® Curved Adjustable Gastric Band	PRODUCT CODE	DESCRIPTION	EA / BX
		RLZB32	Includes ETHICON ENDO-SURGERY® Curved Adjustable Gastric Band with sutureless port and applier
	RLZB32T	Includes ETHICON ENDO-SURGERY® Curved Adjustable Gastric Band with sutureless port and applier with B15LT trocar	1

ETHICON ENDO-SURGERY® Curved Adjustable Gastric Band with Dissector	PRODUCT CODE	DESCRIPTION	EA / BX
		RLZB32DI	Contains one each of RLZB32 and RGBRS1
	RLZB32DT	Contains one each of RLZB32 and RGBRS1 with B15LT trocar	1

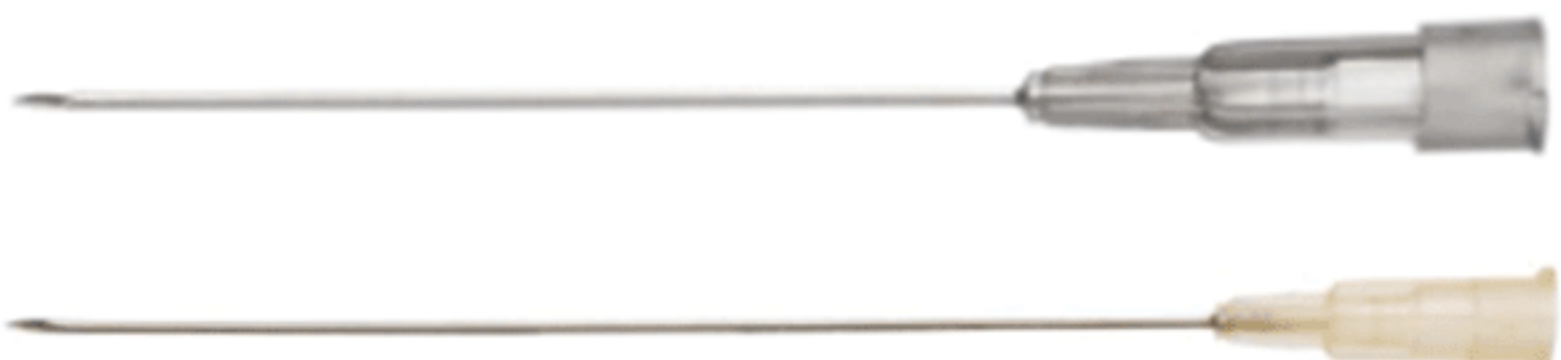

# Other Devices

Whatever your needs during the course of surgery, Ethicon is committed to providing you a solution. From laparoscopic hand instruments to gastric banding, drains, and reservoirs, you can count us to provide you with outstanding value, excellent service, and a broad range of product offerings.

<b>ETHICON ENDO-SURGERY® Curved Adjustable Gastric Band with Dissector and Calibration Tube</b>  	<b>PRODUCT CODE</b>	<b>DESCRIPTION</b>	<b>EA / BX</b>
	RLZB32DG1	Contains one each of RLZB32, RGBRS1 and RGCT360	1
	RLZB32DGT	Contains one each of RLZB32, RGBRS1 and RGCT360 with B15LT trocar	1
<b>ETHICON ENDO-SURGERY® Gastric Band Dissector</b>  	<b>PRODUCT CODE</b>	<b>DESCRIPTION</b>	<b>EA / BX</b>
	RGBRS1	Gastric Band dissector device	1
<b>ETHICON ENDO-SURGERY® Gastric Calibration Tube</b>  	<b>PRODUCT CODE</b>	<b>DESCRIPTION</b>	<b>EA / BX</b>
	RGCT180	Gastric calibration tube, 180 asymmetrical	1
	RGCT360	Gastric calibration tube, 360 asymmetrical	1
<b>ETHICON ENDO-SURGERY® Huber Needle - 50mm, 90mm</b>  	<b>PRODUCT CODE</b>	<b>DESCRIPTION</b>	<b>EA / BX</b>
	RHUB50	Huber needle - 22G, 50mm long	25
	RHUB90	Huber needle - 20G, 90mm long	25
<b>ETHICON ENDO-SURGERY® Sutureless Port and Applier</b>  	<b>PRODUCT CODE</b>	<b>DESCRIPTION</b>	<b>EA / BX</b>
	RLZPT2	Sutureless port and applier only	1



# Other Devices

Whatever your needs during the course of surgery, Ethicon is committed to providing you a solution. From laparoscopic hand instruments to gastric banding, drains, and reservoirs, you can count us to provide you with outstanding value, excellent service, and a broad range of product offerings.

BLAKE® Cardio Connectors		
PRODUCT CODE	MATERIAL	EA / BX
BCC1	BLAKE® Cardio Connector 1:1	1
BCC2	BLAKE® Cardio Connector 2:1	1
BCC3	BLAKE® Cardio Connector 3:1	1

<b>BLAKE® Silicone Drains - Flat</b> 	PRODUCT CODE	MATERIAL	EA / BX
	2210	7mm flat, 3/4 fluted	1
	2211	7mm flat, full fluted	1
	2212	7mm flat, full fluted, 3/16" trocar	1
	2213	10mm flat, 3/4 fluted	1
	2214	10mm flat, full fluted	1
	2215	10mm flat, full fluted, 3/16" trocar	1
	2216	7mm flat, 3/4 fluted, 3/16" trocar	1
	2217	10mm flat, 3/4 fluted, 3/16" trocar	1

<b>BLAKE® Silicone Drains - Hubless</b> 	PRODUCT CODE	MATERIAL	EA / BX
	2226	Hubless, 10Fr round	1
	2227	Hubless, 10Fr round, 1/8" trocar	1
	2228	Hubless, 15Fr round	1
	2229	Hubless, 15Fr round, 3/16" trocar	1
	2230	Hubless, 19Fr round	1
	2231	Hubless, 19Fr round, 1/4" trocar	1
	2232	Hubless, 19Fr round, 1/4" bendable trocar	1
	2233	Hubless, 15Fr round, 3/16" bendable trocar	1
2234	Hubless, 24Fr round	1	

J-VAC® Reservoirs - Sterile		
PRODUCT CODE	MATERIAL	EA / BX
2161	150ml closed wound drainage reservoir	1
2162	450ml closed wound drainage reservoir	1
2163	300ml closed wound drainage reservoir	1



# Other Devices

Whatever your needs during the course of surgery, Ethicon is committed to providing you a solution. From laparoscopic hand instruments to gastric banding, drains, and reservoirs, you can count us to provide you with outstanding value, excellent service, and a broad range of product offerings.

<b>J-VAC® Bulb Suction Reservoirs - Sterile Bulbs</b>		
<b>PRODUCT CODE</b>	<b>MATERIAL</b>	<b>EA / BX</b>
2160	100cc bulb suction reservoir	1

<b>J-VAC® Silicone Drains - Drain Adapters</b>		
<b>PRODUCT CODE</b>	<b>MATERIAL</b>	<b>EA / BX</b>
2209	J-VAC Drain Adapters 1/8"	1
2199	J-VAC Drain Adapters 1/4" (suggested for 19Fr and 24 Fr Drains)	1
2298	J-VAC Drain Adapters 3/16" (suggested for 7mm Flat, 10mm Flat, and 15Fr Drains)	1



# Essential Product Information

## GYNECARE INTERCEED® ABSORBABLE ADHESION BARRIER

### INDICATIONS:

GYNECARE INTERCEED® Absorbable Adhesion Barrier is indicated as an adjuvant in open (laparotomy) gynecologic pelvic surgery for reducing the incidence of postoperative pelvic adhesions after meticulous hemostasis is achieved consistent with microsurgical principles.

### CONTRAINDICATIONS:

The use of GYNECARE INTERCEED® is contraindicated in the presence of frank infection. GYNECARE INTERCEED® is not indicated as a hemostatic agent. Appropriate means of achieving hemostasis must be employed.

### WARNINGS:

The safety and effectiveness of GYNECARE INTERCEED® Adhesion Barrier in laparoscopic surgery or any procedures other than open (laparotomy) gynecologic microsurgical procedures have not been established.

Postoperative adhesions may be induced by GYNECARE INTERCEED® application if adjacent tissues (eg, ovary and tube) and structures are coapted or conjoined by the device, or if GYNECARE INTERCEED® is folded, wadded or layered. Postoperative adhesions may occur in the presence of GYNECARE INTERCEED® if meticulous hemostasis is not achieved prior to application. As with all foreign substances, GYNECARE INTERCEED® should not be placed in a contaminated surgical site.

### PRECAUTIONS:

Use only a single layer of GYNECARE INTERCEED®, since multiple layers of packing or folding will not enhance the adhesion barrier characteristics and may interfere with the absorption rate of GYNECARE INTERCEED®. Care should be exercised in applying GYNECARE INTERCEED® to a pelvic organ not to constrict or restrict it. If the product comes in contact with blood prior to completing the procedure, it should be discarded, as fibrin deposition cannot be removed by irrigation and may promote adhesions formation. Ectopic pregnancies have been associated with fertility surgery of the female reproductive tract. No data exist to establish the effect, if any, of GYNECARE INTERCEED® on the occurrence of ectopic pregnancies. No adequate studies have been conducted in women who have become pregnant within the first month after exposure to GYNECARE INTERCEED®. No teratogenic studies have been performed. Therefore, avoidance of conception should be considered during the first complete menstrual cycle after use of GYNECARE INTERCEED®. The safety and effectiveness of using GYNECARE INTERCEED® in combination with other adhesion prevention treatments have not been clinically established. GYNECARE INTERCEED® is supplied sterile. As the material is not compatible with autoclaving or ethylene oxide sterilization, GYNECARE INTERCEED® must not be resterilized. Foreign body reactions may occur in some patients. Interactions may occur between GYNECARE INTERCEED® and some drugs used at the surgical site. Pathologists examining sites of GYNECARE INTERCEED® placement should be made aware of its usage and of the normal cellular response to GYNECARE INTERCEED® 'to facilitate proper evaluation of specimens'.

### ADVERSE REACTIONS:

The type and frequency of adverse events reported are consistent with events typically seen following surgery. Postsurgical adhesions may occur in the presence of GYNECARE INTERCEED®.



# Essential Product Information

## GYNECARE THERMACHOICE® III Uterine Balloon Therapy System

**INDICATIONS:** The GYNECARE THERMACHOICE III® System is a thermal balloon ablation device intended to ablate the endometrial lining of the uterus in premenopausal women with menorrhagia (excessive uterine bleeding) due to benign causes for whom childbearing is complete.

**CONTRAINDICATIONS:** The device is contraindicated for use in a patient who is pregnant or who wants to become pregnant in the future (**pregnancies following ablation can be dangerous for both mother and fetus**); with known or suspected endometrial carcinoma (uterine cancer) or premalignant change of the endometrium, such as unresolved adenomatous hyperplasia; with any anatomic condition (eg, history of previous classical cesarean sections or transmural myomectomy) or pathologic condition (eg, chronic immunosuppressive therapy) that could lead to weakening of the myometrium; with active genital or urinary tract infection at the time of procedure (eg, cervicitis, vaginitis, endometritis, salpingitis, or cystitis) or with active pelvic inflammatory disease (PID); with an intrauterine device (IUD) currently in place.

**ADVERSE EVENTS:** include cramping/pelvic pain; nausea and vomiting; complications with pregnancy (Note: **pregnancies following ablation can be dangerous for both mother and fetus**); endometritis and risks associated with hysteroscopy; post-procedure symptoms such as pain, fever, nausea, vomiting and difficulty with defecation or micturition; hematometra; rupture of the uterus; thermal injury to adjacent tissue; heated liquid escaping into the vascular spaces and/or cervix, vagina, fallopian tubes, and abdominal cavity; electrical burn; hemorrhage; infection or sepsis; perforation; post-ablation tubal sterilization syndrome; complications leading to serious injury; vesico-uterine fistula formation; or death.

**WARNINGS:** Failure to follow all instructions or to heed any warnings or precautions could result in serious patient injury. The device is intended for use only in women who do not desire to bear children because the likelihood of pregnancy is significantly decreased following this procedure. **Pregnancies following ablation can be dangerous for both mother and fetus.** If uterine perforation is present, and the procedure is not terminated, thermal injury to adjacent tissue may occur if the heater is activated. Endometrial ablation is not a sterilization procedure. Patients who have previously undergone tubal ligation are at increased risk of developing post ablation tubal sterilization syndrome which can require hysterectomy. Endometrial ablation procedures using the GYNECARE THERMACHOICE® III System should be performed only by medical professionals who have experience in performing procedures within the uterine cavity, such as IUD insertion or dilation and curettage (D&C), and who have adequate training and familiarity with GYNECARE THERMACHOICE® III System. Endometrial ablation procedures do not eliminate the potential for endometrial hyperplasia or adenocarcinoma of the endometrium and may mask the physician's ability to detect or make a diagnosis of such pathology. DO NOT perform same-day GYNECARE THERMACHOICE® III procedure and hysteroscopic tubal occlusion/sterilization. Ablation may cause intrauterine synechiae, which can compromise (ie, prevent) the 3-month confirmation test (HSG) for the tubal occlusion device. Women who have inadequate 3-month confirmation tests cannot rely on the tubal occlusion device for contraception. Bench and clinical studies have been conducted which demonstrate that the GYNECARE THERMACHOICE® III procedure can be safely and effectively performed with nickel titanium tubal micro-inserts in place. However, the GYNECARE THERMACHOICE® III procedure should only be performed after the 3-month tubal occlusion confirmation test.

**PRECAUTIONS:** Never use other components with the GYNECARE THERMACHOICE® III System. For the complete list of Precautions associated with the use of this device, consult the GYNECARE THERMACHOICE® III System instructions for use. Rx Only.